

**MANUAL AND  
USER GUIDE**

# WITH THIS SIMPLON BIKE YOU HAVE PURCHASED A PREMIUM QUALITY PRODUCT.

In this manual you will find important information about your new bike. At the end of the manual you will find the bike pass. In case of cause for complaint this should be provided along with the till receipt or invoice.

Please make sure that your bike dealer always completes the bike pass. Keep the bike pass (and ideally the whole manual) as well as the purchase receipt / invoice in a safe place!

Simplon also offers you the possibility to extend the extended warranty for frame and SIMPLON forks by a further 24 months in addition to the 24 month extra warranty provided (72 months in total). **To do this you need to register your bike online under [www.simplon.com](http://www.simplon.com) at the latest within 20 days from the date of purchase** (only applies to customers in Austria, Germany, Switzerland, Liechtenstein and South Tyrol).

Taking care of and maintaining your bike is important to ensure it lasts a long time, with no defects, to give you optimum performance and ride safety.

Due to the wide range of models and choice of equipment offered by SIMPLON this manual may contain information which does not apply to your bike. Photos and drawings may differ to the actually used products and descriptions may be incomplete. So please pay attention to the corresponding user manuals from our component suppliers.

Please take the time to read through the user guide and instructions carefully. Despite the instructions you can and shouldn't try to carry out all the necessary work yourself. Your SIMPLON dealer has the necessary tools and knowledge to keep your new bike on the road "for a long time".

SIMPLON Fahrrad GmbH

**wishes you lots of pleasure and fun with your new SIMPLON bike!**

# BIKE COMPONENTS

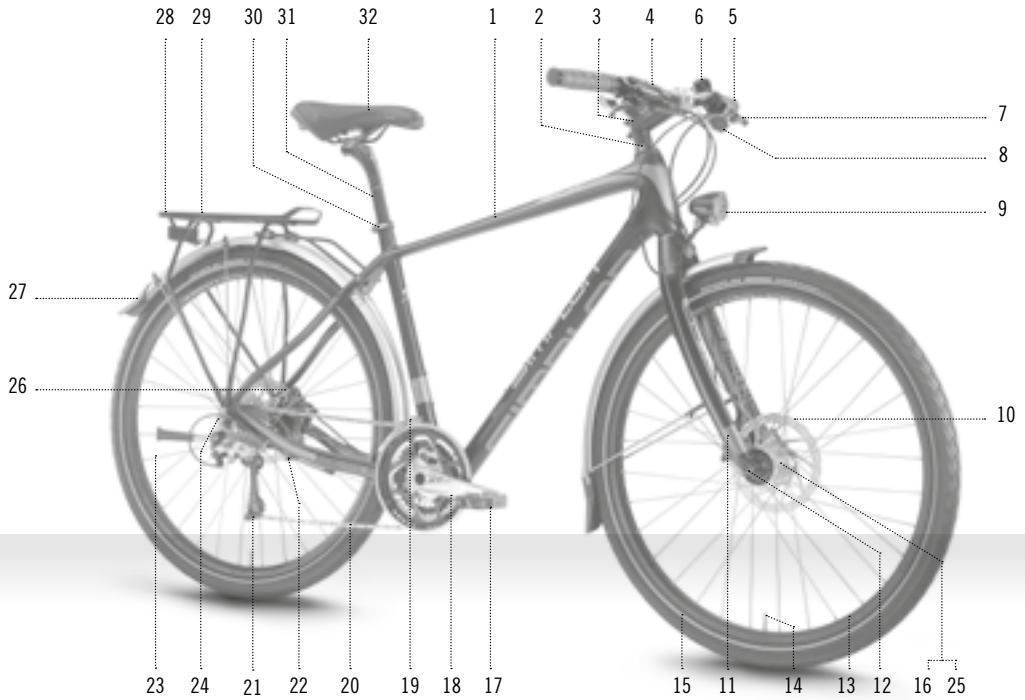

- |    |                          |    |                    |    |                            |
|----|--------------------------|----|--------------------|----|----------------------------|
| 1  | Frame                    | 12 | Quick release hub  | 23 | Spokes                     |
| 2  | Headset                  | 13 | Rim                | 24 | Cassette                   |
| 3  | Handlebar stem           | 14 | Valve              | 25 | Hub dynamo                 |
| 4  | Handlebars               | 15 | Tyre               | 26 | Brake - rear wheel         |
| 5  | Handlebar grips          | 16 | Hub                | 27 | Mudguard                   |
| 6  | Bell                     | 17 | Pedal              | 28 | Rear light                 |
| 7  | Brake levers             | 18 | Chainset           | 29 | Pannier rack               |
| 8  | Gear levers              | 19 | (front) derailleur | 30 | Seatpost height adjustment |
| 9  | Front light              | 20 | Chain              | 31 | Seatpost                   |
| 10 | Brake - front wheel      | 21 | (rear) derailleur  | 32 | Saddle                     |
| 11 | Suspension forks / forks | 22 | Bike stand         |    |                            |

The bike diagram is only to show where the respective parts on the bike are.  
The diagrams may not correspond to the actual bike.

# INDEX

---

|                      |             |                      |    |
|----------------------|-------------|----------------------|----|
| Aheadset system      | 12, 26      | - light front        | 29 |
| Assembly paste       | 28, 45      | - light rear         | 29 |
| Bar ends             | 14, 28 Bike | Load                 | 10 |
| transport            | 40          | MTB                  | 9  |
| Bottle cage          | 41          | Pannier rack         | 10 |
| Bottom bracket       | 26          | Pedals               | 25 |
| Brakes               | 16          | Pedals (set up)      | 15 |
| Chain                | 27          | Pump holder          | 41 |
| Cleaning             | 41          | Quick-release        | 33 |
| Click pedals         | 25          | Rear suspension      | 38 |
| Clothing             | 8           | Ride behaviour       | 7  |
| Coaster brake        | 21 Cranks   | Rims                 | 33 |
| / crank arms         | 26          | Road bike            | 10 |
| Crash                | 43          | Saddle distance      | 12 |
| Crossbike            | 10          | Saddle height        | 11 |
| Disc brakes          | 20          | Saddle (set up)      | 11 |
| Dynamo               | 29          | Seatpost             | 11 |
| Flat tyre            | 42          | Service intervals    | 46 |
| Forks                | 34          | Service tips         | 8  |
| Frame                | 35          | Side-pull brakes     | 21 |
| Frame size           | 11          | Suspension forks     | 36 |
| Full-Suspension      | 38          | Suspension seatpost  | 38 |
| Gears                | 22          | Suspension systems   | 36 |
| Gears (set up)       | 23          | Tips for care        | 44 |
| Gear systems         | 21          | Torque settings      | 47 |
| Handlebars           | 28          | Training on rollers  | 44 |
| Handlebars (set-up)  | 12          | Trekking bike        | 10 |
| Handlebar stem       | 13, 28      | Tubeless tyres (UST) | 31 |
| Headset              | 26          | Tyres                | 30 |
| Hubs                 | 27, 34      | Tyre pressure        | 30 |
| Hub bearings         | 27          | V-brakes             | 17 |
| Hub dynamo           | 29          | Warranty             | 49 |
| Hub gears            | 24          | Wheels               | 31 |
| Hydraulic rim brakes | 19          |                      |    |
| Lights               | 29          |                      |    |

## Imprint:

Publisher: SIMPLON Fahrrad GmbH

Design: Team A5 advertising agency, Dornbirn, Austria

Consulting: Zedler Engineering Office, Ludwigsburg, Germany, [www.zedler.de](http://www.zedler.de)

Reprint, copying or similar (even excerpts) is not permitted.

1st Edition 2017

Any liability, for the publisher and third parties for any excerpts in this brochure, or subsequent damages resulting from this, regardless of type, is excluded.

# CONTENTS

|  |    |                                   |    |
|--|----|-----------------------------------|----|
| <b>Bike components</b>                         | 3  | • Chain                           | 27 |
| <b>1. Before your first ride</b>               | 6  | • Handlebars / Stem               | 28 |
| <b>2. Riding a bike safely and responsibly</b> |    | • Lights                          | 29 |
| • Is the bike fit for the road?                | 6  | - Dynamo                          | 29 |
| • Correct riding behaviour                     | 7  | - Headlight                       | 29 |
| • Appropriate clothing                         | 8  | - Rear light                      | 29 |
| • Our environment                              | 8  | • Tyres                           | 30 |
| • Service Tips                                 | 8  | - Tubeless tyres                  | 31 |
| • Police tips                                  | 9  | - Wheels                          | 31 |
| • Where to use which type of bike              | 9  | - Removing the wheels             | 32 |
| • Special rules for lightweight bikes          | 10 | - Quick-release levers            | 33 |
| • Maximum system weight                        | 10 | - Rims                            | 33 |
| <b>3. Adjusting the bike to your body size</b> |    | - Hubs                            | 34 |
| • Frame size                                   | 11 | • Forks                           | 34 |
| • Saddle height                                | 11 | • Frame                           | 35 |
| • Saddle distance                              | 12 | - Noises                          | 35 |
| • Setting up the handlebars                    | 12 | - Surface                         | 35 |
| - Handlebar height "Aheadset-System"           | 12 | - Invisible damage                | 36 |
| - Handlebar height with adjustable stem        | 13 | • Suspension systems              | 36 |
| - Handlebar angle                              | 14 | - Suspension forks                | 36 |
| - Operating elements                           | 14 | - Suspension seatpost             | 38 |
| - Bar ends position                            | 14 | - Rear suspension                 | 38 |
| • Adjusting the distance of the brake levers   | 15 | <b>5. Useful tips about bikes</b> |    |
| • Setting up the pedals                        | 15 | • Transporting children           | 40 |
| - Shoe contact                                 | 16 | • Transporting bikes              | 40 |
| <b>4. Familiarise yourself with your bike</b>  |    | • Bottle cages / pump holders     | 41 |
| • How to brake properly                        | 16 | <b>6. Care and maintenance</b>    |    |
| - Applying the brakes and their effect         | 16 | • Cleaning                        | 41 |
| • Brake systems                                | 17 | • Flat tyres                      | 42 |
| - V-brakes                                     | 17 | • Crash                           | 43 |
| - Hydraulic rim brakes                         | 19 | • Training on rollers             | 44 |
| - Disc brakes                                  | 20 | • General tips about care         | 44 |
| - Coaster brakes                               | 21 | • Scratches to the frame / forks  | 44 |
| - Side-pull brakes                             | 21 | • Carbon assembly paste           | 45 |
| • Gear systems                                 | 21 | • Service intervals               | 46 |
| - Operation                                    | 21 | • Tightening torque               | 46 |
| - Deraillleur gears                            | 22 | <b>7. Safety notes</b>            | 48 |
| - Hub gears                                    | 24 | <b>8. Warranty conditions</b>     |    |
| - Combined systems                             | 25 | • Warranty period                 | 49 |
| • Pedals                                       | 25 | • Warranty terms                  | 49 |
| - Click pedals                                 | 25 | • Crash replacement               | 50 |
| • Crank arms                                   | 26 | <b>Service (proof)</b>            | 51 |
| • Bottom bracket, headset and hub bearings     | 26 | <b>Bike pass</b>                  | 52 |
| - Bottom bracket                               | 26 |                                   |    |
| - Headset                                      | 26 |                                   |    |
| - Hub bearings                                 | 27 |                                   |    |

# 1. BEFORE THE FIRST RIDE

---

Please read these notes and take them into account before your first ride:

1. Please bear in mind that our bikes are designed for a maximum system weight of 125 kg (bike + rider + luggage). Exception e-bikes, balloon bikes, touring bikes (see "permitted system weight").
2. Use the bike for the purpose it was designed for, i.e. road bikes are not built for off-road use (see "Area of use").
3. Have the saddle and handlebars been set up correctly and tightened? The saddle should be set up so that you can just reach the pedal in it's lowest position with your heel. Your dealer can advise you about the ideal saddle position (See "Setting up saddle" and "Setting up the handlebars").
4. Have you got used to the brakes? First practise braking in a safe area until you have got a feel for the brakes. The bite point and how to apply them can be different on every bike. You need to know instinctively how and which lever activates which brake you (see "braking" and "braking systems").
5. Also get used to the gears. Practise changing gears on a safe area until you know how the levers and derailleurs work (see "gearing").
6. If you've got special pedals on your bike, familiarise yourself with them too. With some system pedals it's not only getting in but also getting out which needs getting used to (see "pedals").
7. Do you know how to operate the lights? You need to know how and where to switch on the lights when it gets dark (see "lighting").
8. If you have a bike with suspension, let the dealer set up the suspension for you (see "suspension").
9. Take time as soon as possible to read through this whole book carefully.

# 2. RIDING A BIKE SAFELY AND RESPONSIBLY

---

## IS THE BIKE READY TO RIDE?

Before each ride you need to check that the bike is working properly. Before you start each ride carry out the following checks before you start and sort out any problems before you set off:

- Are the saddle and bars set up correctly?
- Are the wheels tightened securely in the forks and the frame?
- Have the saddle and the seatpost been tightened properly?
- Have the handlebars and stem been tightened properly?
- Are the brakes working properly? Are they set up correctly? Are the braking surfaces clean and free of grease?
- Are the front and rear lights working correctly?
- Are the tyres intact and have they been inflated to the correct pressure?
- On a suspension bike check whether the suspension elements compress and decompress as usual.



In addition to these constant checks general checks should be carried out regularly:

- Are all screws tight?
- Are the crank bolts tight?
- Does the bottom bracket or the headset have any problems?
- Is the chain o.k. and has it been lubricated?
- Are all spokes tight?
- Do the wheels run true or is there axial or radial deformation?



**DANGER:** If your bike has any of the defects / points listed above then you shouldn't use it. A bike with problems can cause an accident or serious injury.

Simplon can only guarantee the functionality and safety of the components and groups which are available in the modular system and have been tested thoroughly. If you would like to assemble any additional / other components then you need to carry out all the necessary functionality and safety tests.

In bad visibility (rain, fog, sunset, nighttime) please turn on your bike lights early. Reflectors do not offer enough protection for riding at night.

## Appropriate riding behaviour

Your riding ability and behaviour is important to be able to avoid dangerous situations.

- Familiarise yourself with your bike.
- Always adhere to the Highway Code.
- Do not ride in the blind spot of other road users.
- Indicate in advance when you want to turn off or change direction.
- Reckon on other road users mistakes.
- Always ride defensively and according to the conditions.
- Show consideration for pedestrians and hikers.
- Don't drink alcohol or take drugs and ride.
- Always hold the handlebars with both hands.
- Hold your hands on the bars so that you are always ready to brake.
- If possible always brake with both brakes. If you only brake with the front brake there is a danger you will skid and fall off.
- Take care on sandy ground, leaves or wet tracks / roads. Take the reduced traction into consideration when cornering or braking. Reduce your speed accordingly. Danger of falling off.
- Braking performance is reduced considerably with most braking systems in wet conditions. So reduce your speed and brake in good time.
- Change down in good time before inclines.

Rides on field or forest tracks offer a special experience. For such tours you should take the following into consideration

- You should check your bike over carefully before longer rides.
- In unknown terrain ride especially carefully. Hidden stones, potholes or precipices may be dangerous.
- Respect other people using the paths (hikers, horse-riders, cyclists ...).
- Ride in such a way that you don't frighten, scare or endanger them.

- In rugged terrain it's useful to get out of the saddle and absorb bumps with your legs.
- Don't ride on your own. In a group it's possible to help each other if there are any problems.
- Shift your body weight to the rear on steep descents to brake safely.

Take care downhill on mountain bikes! Please note for downhills that not every bike is built for every type of stress. Many downhill passages can only be mastered by very experienced riders, who know themselves, the material and the characteristics of the trails very well. If you master your bike well then the stress on the material is more bearable. Leave the extreme downhills to the professionals and avoid such passages.

## APPROPRIATE CLOTHING

It's safer to wear light-coloured and visible clothing. Please ensure you don't wear wide clothing which may be caught in the chain, wheels, handlebars or pedals. For longer rides we recommend using shorts / tights with a seat insert and a cycle jersey. It should be self-explanatory always to wear a helmet. This should adhere to the current safety norms. By wearing sports glasses, which don't slide around, you can protect your eyes from insects, dirt and wind blast. Always wear shoes which enclose your feet and have a non-slip contact with the pedal.



**NOTE:** Above all please ensure that the clothing on your legs is tight. Baggy or loose clothing may get caught in the chain, wheels, pedals or chainset which can cause you to fall off.

## OUR ENVIRONMENT

- Cycling is a very environmentally friendly method of transport. So that it stays this way please:
- Only ride on marked paths, where cycling is allowed (ask if you are in any doubt). Riding cross country is generally not permitted. Respect private property.
- Avoid making unnecessary noise, as everyone wants to relax in nature.
- Take your litter home with you.
- To take care of your bike only use environmentally-friendly cleaning and care products.
- Adjust your riding style to suit the traffic, road and terrain conditions to avoid endangering yourself and other people.

## SERVICE TIPS

You have bought a premium quality SIMPLON bike. Depending on the circumstances how you use the bike we recommend you to clean and conserve your bike regularly so that it keeps its value. (Read the care and maintenance tips in Chapter 6).

**NOTE:** After 10 to 15 hours of riding or after roughly 200 km you should let your SIMPLON bike dealer check your bike over completely for you. At regular intervals (depending on use and conditions), but at least 1x year you should have your bike checked over, where all bearings are cleaned and re-greased.

Depending on your knowledge and experience you can also carry out some service and maintenance work yourself. All work should only be carried out with the proper tools. If you are uncertain with any maintenance work carried out yourself please ask your SIMPLON dealer for help!



## LEGAL REQUIREMENTS

Always lock your bike up when you are not using it. Steel cables, U-locks or cable locks are the best. Lock your bike up with the front and rear wheel to permanent objects (i.e. street lights). Even a lock which only stops one wheel is always better than no lock at all.

MTBs, offroad trekking bikes, fitness bikes, cyclocross bikes and road bikes are pure sports devices and do not adhere to the Highway Code in Great Britain. According to local laws to use them on public roads you should upgrade your bike accordingly. The following minimum requirements may apply, depending on the country:

- two independent working brakes
- a clearly audible bell
- reflector strips on the sidewalls of the tyres
- yellow reflectors on the pedals
- a red rear reflector (also integrated into the rear light)
- a red rear light
- a headlight which shines to the front and whose beam hits the road approximately 10 m away
- a white reflector at the front (also integrated into the headlight)
- during daylight hours and good visibility the headlight and rear light are not needed in Great Britain

For longer rides it's possible that the bike may have extra load (pannier bags, child). Please note that additional load increases the braking distance required. It is only allowed to transport children in DIN approved children's seats. Only people over 16 years old are allowed to carry children. Transporting children over 7 years old or luggage more than 22kg is forbidden according to the German road traffic regulations (StVZO). Accessories need to adhere to the legal regulations of the Highway Code of Great Britain. Please ask for original SIMPLON spare parts.

## AREAS FOR USE

| BIKE TYPE            | ROAD TYPE              | Complies with Highway Code of Great Britain |
|----------------------|------------------------|---|
| MTB Off-road / Roads | no                     |   |
| E-MTB                | Off-road / Roads       | no  |
| Cross                | Light off-road / Roads | no  |
| Trekking             | Roads / Paths          | yes   |
| Comfort              | Roads / Paths          | yes   |
| E-Bike 25km/h        | Roads / Paths          | yes   |
| E-Bike 33km/h        | Roads / Paths          | no  |
| Sport                | Roads                  | no  |
| Cyclocross           | Off-road / Roads       | no  |
| Road bike            | Roads                  | no  |

**Mountain bike:** The mountain bike was basically developed for using off-road. Most MTBs are equipped with suspension units, which absorb bumps and offer improved road grip, which makes the bike more controllable. A mountain bike is designed for stress and load in rough terrain, however it is still not indestructible! Also within this category there is a difference in use:

- **Hardtail / Race-FS:** Mountain bikes with up to 100mm travel at the front (hardtail) or front and rear (Race FS) are designed for making fast progress. They are designed for dirt roads and occasional jumps up to a maximum height of half a metre.
- **FS 130-160 mm travel:** Full-suspension mountain bikes with 130 to 160 mm travel are designed for rough terrain and jumps up to a maximum of one metre in height. This bike category is not designed for regular or permanent use in bike parks.

NOTE: Rough landings after jumps can increase stress and forces acting on frame and components dramatically and can result in damages.

**E-MTB:** Mountain bikes with e-drive support are designed for rough terrain and jumps up to a maximum of half a metre in height.

**Cross:** The Cross bike is especially designed for riding on natural cycle paths and good forest tracks, the tyres are always in contact with the road. To ride on public roads it needs to be upgraded accordingly (required by law).

**Trekking-/ Comfort:** These bikes were designed for riding in towns & cities as well as for occasional trips on gravel tracks (i.e. rides out in the country). You won't reach such a high speed as a road bike and they are not designed for riding off-road. Both tyres are always in contact with the ground. Depending on the chosen equipment they may fulfil the Highway Code in Great Britain, which means they can be used on public roads.

**E-Bike:** describes trekking, sport and comfort bikes with additional support from electric drives. These bikes were designed for riding in the city, as well as for occasional rides on gravel tracks (i.e. rides out in the country), both tyres are always in contact with the ground. Models with support up to 25 km/h comply with the Highway Code in Great Britain depending on the chosen equipment. Models with support up to 33 km/h are not allowed on public roads and may only be used on private land.

**Sport:** These bikes are basically virtually road bikes, but offer a less aggressive seating position. They often have narrow light-weight high-pressure tyres which are pumped up hard. This means they are very fast, but should only be ridden on tarmaced roads or very good gravel tracks. Both tyres are always in contact with the ground.

**Cyclocross:** The bikes are sport machines which are designed for riding in medium terrain. They are ideal for training in the cold and also to improve your riding technique. Occasional small jumps over drops and steps up to 20 cm in height are allowed, but the frame and components are not designed for higher jumps.

**Road bike:** The road bike is the lightest, most aerodynamic and thus the "fastest" bike. It is only used on tarmaced roads, which is why it is ridden with narrow tyres and high-pressure. The frame and components are especially lightweight and thus not designed for stress off-road nor jumps. Thanks to our own designed frame geometry and the racing bars the rider has an optimum position for riding uphill and a low aerodynamic seating position for riding fast. It is a pure racing machine.

## SPECIAL RULE FOR LIGHTWEIGHT BIKES

For road bikes, which weigh under 11kg, there are special rules regarding lighting. During daylight and with good visibility these bikes may be used without lighting, reflectors and bell on public roads (in Germany reflectors and bell are necessary, lighting must be carried with you).

In different countries there are different regulations regarding lighting. Please find out about the relevant applicable legal regulations in your own country.

## PERMISSIBLE SYSTEM WEIGHT

Just like cars a bike is only built for certain loads. Never load the pannier rack with more than the permissible maximum load stamped on the rack. If the bike is overloaded, then damage may occur to the bike, which could cause an accident. Considerate riding (don't ride up kerbs, through potholes, pedal smoothly) will look after your bike and prolong the life of your frame and parts.



NOTE: Your bike may only be loaded with a maximum of 125 kg system weight (bike plus 1 person incl. child if child's seat is mounted, plus luggage). For Simplon travel bikes a maximum of 160 kg system weight is allowed, for Simplon e-bikes a maximum system weight of 140 kg (with exception of Chenoa Uni e-bike max. system weight 125 kg). Only load the pannier rack with a maximum of 25 kg, for the "Tubus Fly" pannier rack model the maximum load in combination with our frame is 10 kg.

Please note that with regular trips with maximum load the product life of different components may be restricted (especially wheels and are dependent on the riding style and properties of the roads).



NOTE: When transporting luggage with your bike take into consideration that the ride behaviour of your bike will change due to the load. Even if you are carrying a heavily laden rucksack with you your centre of gravity will change considerably.

### 3. FITTING THE BIKE TO YOUR SIZE

#### FRAME SIZE

Your individual bike should fit you. The best and most expensive material will not help you if the size of the frame is not suitable for you. Normally the correct frame size is decided between you and the dealer. Now you can do the fine tuning. You can find out how to do this in the next chapter.

#### SADDLE HEIGHT

The right saddle position is determined by the pedalling action. During normal pedalling, at the lowest point of the crankset, the furthest point of the pedal away from the saddle the leg shouldn't be completely extended. If the seat position is too high, then it's difficult to overcome the lowest point, pedalling will become uneven. If the saddle position is too low the knee will suffer, too high a position the hip will suffer.

- The saddle is fitted to a seatpost.
- The saddle height can be adjusted by loosening the seat clamp bolt.
- After this the saddle height can be adjusted. Make sure that the part of the aluminium seatpost which is inside the seat tube is well greased. Except for carbon frames and / or carbon seatposts these must be grease free and assembled using special fitting lubricant.
- The saddle height should be set up so that the leg is fully extended when the heel is on the pedal in its lowest position. (To do this shoes with flat soles or flat heels should be used!). The hip should stay straight when doing this.
- Set the saddle straight by placing the nose of the saddle over the bottom bracket housing or over the top tube.
- Finally fix it in position by tightening the clamp bolt (please observe maximum torque settings).
- The seatpost may only be extended to the maximum marking.

If the seatpost is secured with a quick-release lever instead of a clamp bolt, then this can be moved by opening and closing the quick-release lever. Please only tighten the quick-release lever "hand-tight" and with feeling. If the seatpost isn't tightened enough, then open the quick-release lever again, tighten the nut on the opposite side a little bit and then close the lever. Repeat this process as necessary until the seatpost is tightened correctly.



correct saddle height



**NOTE:** Especially with carbon seatposts tighten the clamp carefully. If you tighten it too tightly then the seatpost can be damaged. Roughen up the inside of the seat tube and carbon seatpost in the clamping area with emery paper or use a carbon assembly paste. This helps to fasten the seatpost using very little clamping force. Adhere to the maximum torque settings according to the enclosed torque settings table.

Especially for small frames or FS-bikes it might be that it's not possible to insert the seatpost deeply enough into the frame. It is allowed to shorten the seat post accordingly, however it must be ensured that the shortened seatpost is also inserted at least 90mm into the frame.

**!** **DANGER:** A quick-release lever which has not been tightened properly may become undone again. This will lead to the saddle moving uncontrollably during the ride. This can cause a serious accident.

**!** **DANGER:** The seatpost must be inserted at least to the minimum insertion depth (see marking) in the frame. Otherwise the seatpost or frame may break which can cause a serious accident or injury. If the saddle is set up correctly you should be able to touch the ground with the tips of your toes.



## SADDLE DISTANCE

At the upper end of the seatpost you can set the saddle tilt and the saddle length to make your bike fit your personal seating preferences. You can only adopt a relaxed seating position if you have set the saddle to a horizontal position. Via the saddle distance you can adjust the distance to the pedalling position and to the handlebar grips. As this process is different depending on the type of seatpost we recommend you to let the dealer set this up for you. The adjustment area for the saddle is very small. Via a different stem length you can achieve a considerable change in length between the saddle and the bar grips.

## HANDLEBAR SETTING

The handlebar height is very different depending on the type of bike and use. The lower the handlebars are mounted the more aerodynamic the position. The rider can put more weight on the front wheel when the handlebars are set lower. However a very bent-over position is much more tiring: the strain on the wrists, the arms, the upper body and the neck increases.

## HANDLEBAR HEIGHT WITH "AHEADSET" STEMS

For bikes with the "Aheadset" system the stem is clamped directly onto the outside of the steerer tube. The stem can't be moved up. But it can be moved down by removing the distance rings located beneath the stem. However the steerer tube then needs to be shortened accordingly and the headset re-adjusted. A further customisation can be made by fitting a stem with another length or another angle or with many models simply by reversing the stem.

- You can remove the existing distance rings (spacers) and then add them again above the stem on the steerer tube (not allowed on forks with carbon steerer tubes) or shorten the forks.
- The assembled stem may only protrude 2mm over the edge of the steerer tube. We recommend you to let the steerer tube protrude slightly over the stem and add a thin spacer over the stem.
- If you want to reverse the stem then you need to loosen the front handlebar clamp screws and remove the cover. The handlebars can then be removed, the stem reversed and put back in place and the handlebars can then be assembled in the correct position again.
- Now adjust the headset with the adjusting screw again and tighten the stem with the clamping screws.

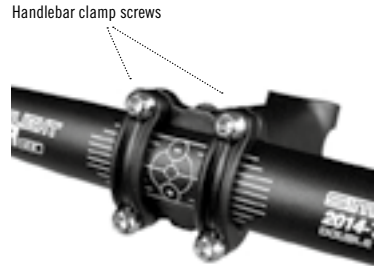
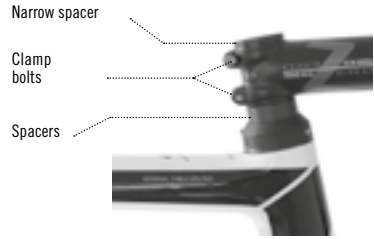

**NOTE:** If you tighten the clamping screws too tightly then you can damage the tube on forks with carbon tube. Put carbon fitting lubricant on the surface between the stem and the steerer tube and tighten the clamping screws alternately until it's not possible to turn the handlebar stem any more. By doing this you can achieve sufficient clamping force even below the maximum torque settings quoted by the stem manufacturers.

## HANDLEBAR HEIGHT WITH ADJUSTABLE STEM

For stems with adjustable angle the position can be simply changed. Make sure that the position is not exceeded and that the brake and gear cables are long enough.



**NOTE:** the stem should not be at an angle, but should be aligned with the front wheel. Also make sure that all screws are fastened tightly and that the maximum torque settings for the screws have not been exceeded.



**DANGER:** Changing the handlebar height needs specialist knowledge and should only be carried out by a mechanic.



**DANGER:** Check that the handlebars and stem are in the correct position and have been tightened properly. Also check whether the handlebars - stem unit can be turned against the forks or whether the handlebars may be turned. If necessary tighten the screws even more. However do not tighten them more than the recommended maximum torque settings.

## HANDLEBAR TILT

The handlebar ends are often slightly at an angle. Adjust the handlebars so that your wrists are not at too much of an angle. For road bike bars the straight piece of the lower bar should be parallel to the ground or tilting slightly downwards at the rear.

- To do this loosen the screw on the underside or top of the stem.
- Turn the handlebars into the desired position.
- Make sure that the handlebars are clamped in the middle by the stem.
- Tighten the screws alternately and carefully again without exceeding the maximum torque settings.
- Check that the handlebars are fastened tightly.

After the angle has been adjusted then you need to adjust the position of the brake and shift levers again (except for road bike bars).

- To do this loosen the screws on the grips.
- Bring the brake / shift levers into the ideal position.
- Tighten the screws on the grips again and check whether these are tight, by trying to turn them.



**NOTE:** After each time you've moved the handlebars check that the stem - handlebars unit has been securely tightened. A sudden slip of the handlebars can cause a crash and serious injuries.

## OPERATING CONTROLS

Via a different number of spacers, different handlebar shapes and stem geometry but also the possibility to vary the angle of handlebars, stem, brake and shift levers the position of the operating controls and the grips can be optimised to suit the rider and the riding conditions. However it can't be excluded that even with an optimum setting for all components to the riding conditions that in case the handlebars turn around a component of the steering controls will hit the paint or the top tube of the frame and damage it. If you are worried that this may be the case with your bike, check carefully when you turn the bars around more than 90 degrees whether they touch the frame or not. If this is the case you can change the angle and position of the control levers. If this is necessary you may have to make a compromise for the optimum position of the grips.



**NOTE:** If the optimum grip position is important for you and components may touch the top tube when you turn the handlebars (which often happens in reality), then we would like to advise you that any damage caused to the top tube or its paint is not covered by guarantee or warranty.

## BAR END POSITION

Bar ends are added so that the rider has additional possibilities to grip the bars especially when honking up climbs. For this the bar ends should be in a slightly upright position between 15 and 25 degrees. Make sure that the bar ends on both sides are in the same position. SIMPLON carbon handlebars have reinforcements at the end of the bars. This is why it's only allowed to mount the bar ends when the handlebars haven't been shortened.

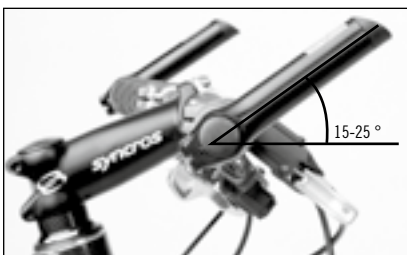



**DANGER:** in situations, where you need to be ready to brake, you shouldn't hold the handlebars by the bar ends as you can't reach the brake levers from the bar ends and won't be able to react quickly in dangerous situations.



**DANGER:** Every time after you have moved the bar ends check that they are firmly fixed to the handlebars. A sudden turn of the handlebars can cause you to fall off and lead to serious injuries.

## SETTING THE REACH FOR THE BRAKE LEVERS

With most brake levers you can set the reach for the lever to the handlebar grips. By doing this you can bring the brake lever close to the bars.

- If the brake pads touch the rims after moving the lever a short distance the brake needs to be adjusted as well as the reach distance to the lever.
- The brake lever adjustment screw (small grub screw) is located on most brake levers, where the brake inner cable enters the brake lever mount. Turn this adjustment screw clockwise and watch how the position of the lever changes as you do so.
- If you have reached the desired gripping distance check whether there is enough reserve on the lever before the brake pads touch the rims.
- If necessary maybe the brakes need to be adjusted again.

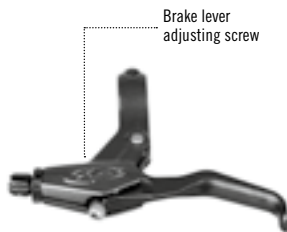

## PEDAL SETTINGS

When you are pedalling the balls of your feet should be over the centre of the pedal axle. Many bikes are equipped with click pedals. A plate, which is firmly screwed to the shoe, then locks into the pedal. With a light sideways movement you can release the shoe from the pedal (the release force can be adjusted with many pedals).



**NOTE:** When you are fitting the shoe plate please make sure that your foot doesn't touch the crank. Your toes shouldn't touch the front wheel in any position.

### Fixing the shoe plate:

- The plate should be fixed to the shoe so that the ball of the foot is over the axle of the pedal.
- When pedalling the foot should be in its natural position.
- Tighten the fixing screws properly. If the plate is loose then it's nearly impossible to get out.

### Set the release force:

- The release force can be changed by turning the small adjusting screw on the pedal.
- Check the tension by clicking in and out of the pedals several times.
- At the beginning it's recommended to use low tension, so that it's easier to get out of the pedals.
- For pedals with a double-sided mechanism it's necessary to set the release tension for each side of the pedal separately.

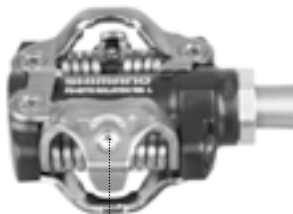

Adjusting screw

Practise getting into and clicking into your pedals in a area which is free from traffic and undulating terrain until you've got used to the click pedals.



**NOTE:** There is no unilateral standard for click pedals. As the shoe plates and pedal mechanisms need to be suitable for each other we recommend only used original shoe plates. Unsuitable shoe plates may prevent release out of the pedals and could cause you to fall off.

## AVOID CONTACT BETWEEN YOUR SHOES AND THE FRONT WHEEL

If you're riding slowly you shouldn't pedal if you have turned the handlebars. Modern performance bikes are constructed using a short wheelbase, where the front wheel is close to the pedals. It's possible if you ride very slowly and turn the bars then your shoe may touch the front wheel or the mudguard (see diagram). At normal speed the bars aren't turned so far that this could happen.



**NOTE:** Touching the front wheel or mudguard with your shoe may cause you to lose control of your bike and fall off. Click your shoes out of the pedals when you're turning slowly.

# 4. FAMILIARISE YOURSELF WITH YOUR BIKE

## BRAKING TECHNIQUES

The brakes are the most important components on your bike. Incorrectly mounted or wrongly adjusted brakes could be extremely dangerous or even fatal. You should be able to reach your brake levers comfortably and use them. If you are not sure that you can maintain or set them up correctly, please visit your SIMPLON dealer.



**NOTE:** Before every ride we recommend you to check that your brakes are fixed securely and set up correctly. It's important that you understand how to use the brakes correctly. If you use the brakes incorrectly you may lose control of your bike which may lead you to crash and cause you serious injury.

Practise developing a feeling for braking in a safe place where there is no danger from the relief of the terrain or from traffic on public roads (i.e. car park). As every bike reacts differently you should familiarise yourself with the brakes to find out how much pressure you need to apply to the brake levers and how the brakes respond. You should know instinctively which brake lever controls which brake. Always apply the rear and front brakes at the same time. In this way it's possible for the front brake to deliver better braking performance.

## BRAKE MODULATION AND POWER

Front brake:

- high performance braking
- increased danger of falling off

Rear brake:

- low performance braking
- low risk of falling off





**DANGER:** You should apply both brakes carefully. The front wheel should not skid. A skidding front wheel often leads to a crash.

With emergency stops the weight shifts from the rear to the front, the rear wheel becomes lighter. On surfaces with good grip there is a danger of going over the bars. Especially when you are riding downhill this problem is exacerbated. This is why you should try, when doing an emergency stop, to shift your body weight as far back as possible.



**DANGER:** longer braking distances. In wet weather the braking effect on your bike decreases and the tyres have less traction on the ground than in dry weather. Adjust your riding style accordingly and reckon on longer braking distances in wet weather.

Remember that your bike becomes heavier if you have a child on the child's seat, luggage on your bike or are wearing a rucksack on your back. This also has an effect on the braking behaviour and the stopping distance will become longer.



**NOTE:** Only use appropriate spare parts for repairs. This is the only way the functionality can be guaranteed. All parts of the brake system must be compatible with each other!



**NOTE:** Check your brakes before every ride. Damaged brake cables, where for example individual strands of wire are protruding or hydraulic brake lines are leaking must be replaced immediately. The brake lever must always have a reserve. If you have to do an emergency stop then the brake lever shouldn't touch the handlebars.

## BRAKE SYSTEMS

### V-BRAKES

Settings: Brake inner cables wearing in and the natural wear on the brake pads make it necessary to re-adjust the brakes after a period of time. You can also change the brake lever distance using the adjustment screw.

- First check whether the brake pads have worn down below the minimum thickness.
- The adjusting screws can be found where the inner cable goes into the brake lever on the bars.
- Loosen the knurled cable adjustment screw and the "free travel" when you pull the brake lever will be reduced.
- If you have reached the desired setting, lock this, by tightening the locking ring against it.
- If you can't get the desired setting then have your brakes checked over by your dealer. The brake lever always has to have a reserve amount of travel. It shouldn't touch the bars when you have to do an emergency stop.

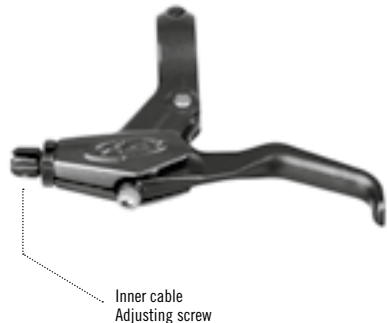

V-brakes are characterised by the high transmission ratio of the brake calipers. For these to work properly you need to use the appropriate brake levers.

Check whether the inner cable fixing screw is tightened properly on the brake caliper, otherwise the inner cable may become loose. Replace damaged brake cables immediately. Otherwise there is a danger the brakes will fail which could lead to a crash and injury.

Brake cable fixing screw



Dirty, smeared or worn out brake blocks have a terrible braking effect. Always replace brake blocks in good time (in pairs). To maintain the functionality of the brakes remove the brake inner cables from the outer casing and grease them regularly (at least 2x year). Also the moving parts of the brakes should be lubricated again with this process. Make sure that the brake block or rims do not get any grease or oil on them. Take into account that dirty brake blocks could cause more wear & tear on the rims. Also riding in very cold conditions leads to a change to a hardening of the brake blocks and consequently to a higher wear & tear. Clean the braking surfaces and also the grooves in the brake blocks regularly and remove any grains of sand or metal shavings.

When it's wet the brake pads wear considerably faster. Check the thickness of the brake pads and the braking performance after every ride in wet conditions. When you replace the brake pads only use brake pads compatible with the brakes and rims.

**NOTE:** The degree of wear & tear on the pads can be seen from the indicators which are often grooves in the brake pads.



**!** **DANGER:** Clean and check the state of the rim. Worn rims should also be replaced in good time (for your safety preferably sooner than later). Badly worn sides of rims may break and cause serious crash injuries.

The brake pads must be adjusted carefully and accurately:

- The distance between the brake pad and rim should be at the maximum 2mm on each side. Always adjust the brake with the least possible play to the rim.
- The brake pads should be positioned parallel to the rim. The height and the angle of the brake pads should be set so that they cannot slip off the rim even under emergency stop braking conditions. If the brake pads are set too high then they can rub on the tyre. Then the sidewall of the tyre will be damaged and the tyre can burst. If the brake pads are set too low these could slide down into the spokes and stop the wheel.
- To get rid of any possible screeching occurring from the bikes it is recommended to set the brake pads up in a slight V-form.



Max. 2 mm gap on each side

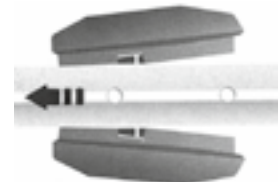

V-form in the direction of travel

- Both brake calipers must touch the rim at the same time. If the brake pads only touch the rim on one side, then either the brake blocks have been unevenly mounted or the spring tension of both brake blocks is not equal. The spring tension is adjusted differently depending on the type or brake models. Please consult your dealer.
- Setting up the brake pads onto the rims requires a considerable deal of skill. Have your mechanic do this for you.

**!** DANGER: Incorrectly set-up or not fully-tightened brake pads can slip off the rim and go into the spokes. This would cause the wheel to stop suddenly and it could come to a serious crash and injuries. Or it could damage the tyres so that they suddenly burst which would also cause serious injuries.

**>** Please find further operating, setting and maintenance notes in the brake manufacturer's user guide which is included with the bike.

## HYDRAULIC RIM BRAKES

Essentially the same guidelines and warnings apply as for V-brakes.

**!** DANGER: With hydraulic brakes pay special attention as to whether the cable lines are airtight. If these are oily, then maybe the hydraulic lines or connections are defective. This can cause the braking effect to deteriorate considerably and it's possible that the brake system will fail completely. Then riding is no longer controllable which can lead to a serious crash and subsequent injuries.

To remove the wheel release the brake quick-release so that you can remove the brake unit. Be careful that you don't lose the washer from under the brake unit. Make sure that when you mount the brake unit that the brake pad is at exactly the same height of the rim brake surface. It shouldn't touch the tyre in any position or slide below the rim.

To compensate for the brake pad wear the adjusting screws on the brake levers need to be adjusted. Some brake types can be set with a rotational knob on the brake lever. The distance between the pad and the rim should be 2 mm on both sides.

With hydraulic rim brakes also check the wear & tear regularly on the brake pads and the setting of the brake pads to the rim. Worn out brake pads can be seen from the grooves integrated into most brake pads. If the pad is worn down to these grooves then the pads should be changed:

- to exchange the brake pads the settings screws on the brake levers need to be turned back.
- then unclip the old brake pad from its holder
- clip the new brake pad in

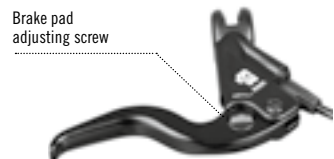

**>** Please read the detailed user, setting and maintenance notes from the brake manufacturer's user guide which comes with the bike.

## DISC BRAKES

Disc brakes have the advantage that they don't wear down or heat up the rims. This means the risk that the tyre or tube slips on the rim or the valve is torn off decreases. Additionally disc brakes offer very good braking performance (even in the wet).

**NOTE:** Please wear in new the brake pads and brake discs. To do this roughly 30 emergency stops from approximately 30 km/h to a standstill are needed. If there is air in the hydraulic system please bleed it. Many disc brake pads only reach their full braking power once they have been heated up from braking. Heat your brakes up by braking on a stretch that you know, with no traffic and a slight descent and keep pedalling. When you do this only use one brake. Brake pads which aren't heated up from braking tend to glaze over and are subject to fading.



Generally with hydraulic systems all components should be checked for leakage before every ride. Check the brake pads regularly for wear & tear. If they don't have the minimum pad thickness any more (See manufacturer's guide) then replace the brake pads.

Under no circumstances should you get oil on either the brake discs or the brake pads. Otherwise the functionality of the brake will be severely limited and the full braking performance can only be achieved by replacing the brake pads. Even with disc brakes which are set up correctly sometimes slight friction noise or even screeching noises (especially when it's wet) may occur.



**NOTE:** with hydraulic brakes air may enter the system for example when the bike is turned upside down. To avoid this never turn the bike upside down or hang it up. If you have to take the wheels off, it's very important to insert the distance spacers into the brake calipers which were delivered with the brakes. If you don't do this then air may enter the system. The result would be either the brakes work very badly or the whole brake system fails.

The correct setting for the brakes differs depending on the manufacturer and may be very different even from model to model. This is why we recommend you read the brake manufacturer's instructions which are delivered with the bike very carefully.

**NOTE:** For bikes with disc brakes and quick release with plastic washers it's important to have the hub quick release mechanism on the opposite side of the frame to the brake disc.



**DANGER:** Brake discs and brake calipers become very hot when used a lot and may cause burns if you touch them. Air in the brake system may lead to a complete failure and serious injury. If you notice any changes in the pressure point of the brake lever then the brake system needs to be bled. Always brake alternately with the front and rear brakes. Permanent braking may lead to the brake system overheating and then to total failure.



For detailed user, setting and maintenance notes please read the brake manufacturer's user guide which comes with the bike.

## COASTER BRAKES

With modern bikes back-pedal brakes are losing popularity as these often have several disadvantages compared to the hand-operated braking systems. On longer descents where you brake often for a long time the brake drums will get so hot that the lubricating film of the brake drums evaporates. This means that the braking effect is increased considerably and it's not possible to apply the brake with feeling any more.



**DANGER:** If the brakes have heated up from braking then you should give them a chance to cool down. Otherwise it could result in a dangerous crash and severe injuries. If you touch the hot brakes or hubs you may burn yourself. Only touch the hot brakes after at least 30 minutes.



Please read the brake manufacturer's user guide which was delivered with the bike for how to use, set up and maintain the brakes.

## SIDE-PULL BRAKES

These brakes are the most common construction for road bikes. Generally the same safety and warning notes apply like for V-brakes. Setting up: the brake cable tension can be changed by turning the adjusting screw on the brake body. Turn it until the desired setting for the lever path has been reached. If the brake blocks are rubbing on one side of the rim then either the brakes are mounted at an angle or the spring tension of both the brake calipers isn't the same. How to set the spring tension differs depending on the brake model. Please consult your dealer.

Check the side-pull brakes are working properly:

- Check whether the brake pads are set up exactly to the rims and the pads are still thick enough.
- Do both brake calipers touch the rim at the same time?
- For emergency stops, do the brake levers offer an exact bite point?
- Does the lever not touch the handlebars?



For detailed instructions, setting and maintenance notes please read the brake manufacturer's user guide delivered with the bike.

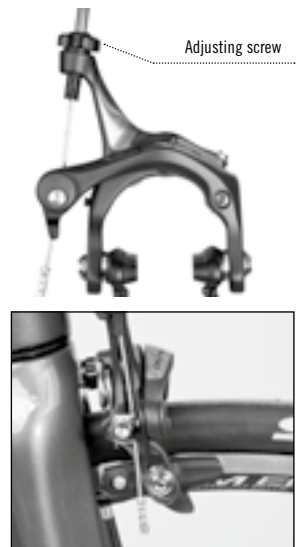

## GEAR SYSTEMS

### OPERATING

Begin by changing gear by pressing a button or for grip shifters, a short twist of the wrist. The left shift lever operates the front derailleur, the right shift lever operates the rear derailleur. Change up or down a gear in good time so you can keep your usual cadence rate (ideally this is between 60 and 90 revolutions of the crank per minute).



**NOTE:** All gear components, shift levers, shift cables must be compatible with each other. For repairs only use original spare parts. Only by doing this is it possible to guarantee problem-free gear shifting.

On road bikes the shift levers are integrated into the brake levers. With Shimano by moving the whole brake lever to the inside you can switch to a larger chainring. If you move the smaller inner lever on it's own then you can change down to a smaller chainring.

With Campagnolo if you use the small lever hidden behind the brake lever then you change up to a larger chainring, by putting pressure on the thumb lever on the inside of the lever you can change down to a smaller chainring.

With SRAM a short movement on the gear lever changes you to a smaller chainring and larger movement of the shift lever to a bigger chainring.

Practise changing gear correctly on an area free of bumps / undulations and traffic until you have got used to the gears.

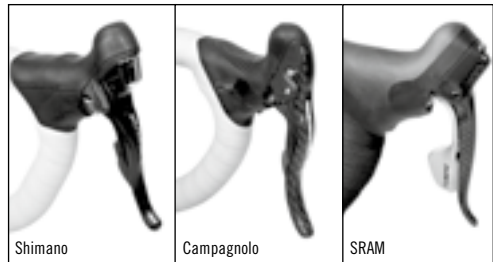

## DERAILLEUR GEARS

The integrated index system enables you to change gear quickly and precisely. You need to keep pedalling when changing gear (just keep pedalling with no pressure). Do not change gear when pedalling backwards as you might stop the derailleur and damage the bike.

Avoid gears where the chain is very skew-with. Don't try to change the chain so that for example the chain is on the largest chainring at the front and on the largest cassette at the back. If the chain is very skew-with then the wear & tear on the chain, chainring and cassette will increase or there will be rubbing noises.

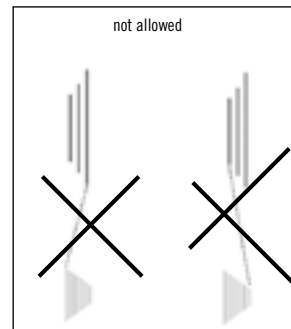

Modern shifting systems are equipped with a lot of help on the chainrings and cassette sprockets for changing gear. These systems need a certain ride-in time. With new chain wheels and problematic gear changing manoeuvres chainsuck may occur (jamming the chain on the chainring). In such a case release the jammed chain and check the chainring (there might be a slight burr, which will cause further jamming). A burr which may have occurred should be filed away carefully.

We recommend you to be especially careful with the gears in the first days (100 km) and only to change gear at the front when the pedal pressure is low.



**DANGER:** Let the front derailleur be set by a dealer / mechanic. If the front derailleur is set up incorrectly the chain can jump off the chain ring which may lead to a crash.

The gears for your new bike were set up in the factory and checked by the dealer. Despite this the gears may have become out of line for different reasons (bike fell over, crash, manipulation or settling in).

- If the chain doesn't change onto the large sprocket easily but easily onto the smaller sprocket, then turn the adjusting screw anti-clockwise (+), until the chain changes easily onto the larger sprocket.
- If the chain doesn't change easily onto the smaller sprocket but easily onto the larger sprocket, then turn the adjustment screw clockwise (-), until the chain changes down easily. If your gears still don't work properly, then have them set up by a mechanic!
- You can also adjust the gears by the adjusting screws on the shift lever or frame bracket.

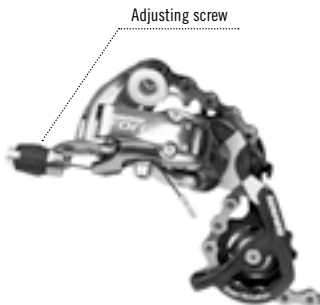

So-called limiter screws on the rear derailleur prevent the derailleur from going into the spokes or the chain from jumping off the smallest sprocket. Set it up as follows:

- Change into the largest gear. The shift inner cable is fully relaxed and the chain runs on the smallest sprocket. Make sure that the jockey wheels of the derailleur are directly under the teeth of the sprocket.
- If this isn't the case use the limiter screws, often characterised with the letters H (for high gear) and L (for low gear). The high gear means a high gear ratio, i.e. a small sprocket.
- If the chain doesn't change onto the smallest sprocket, then the screw H needs to be turned anti-clockwise. If the chain jumps over the smallest sprocket then turn the screw H clockwise.
- If the chain doesn't change onto the largest sprocket then turn the screw L anti-clockwise. If the chain jumps too far inwards then turn the screw L clockwise. Make sure that the derailleur doesn't end up in the spokes.

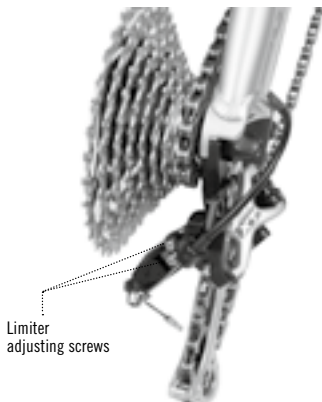

After a fall or when the derailleur gets knocked there is a danger that the derailleur or the hanger is bent. After changing the wheels check the derailleur settings, especially if you are using a different sprocket range. To make these adjustments to the derailleur you need some practice and experience. Have them set up by a mechanic.

Badly adjusted gears increase the wear & tear and can cause considerable damage to the bike. Never change to the largest or smallest sprocket with badly adjusted gears. The chain could get jammed between the spokes and sprockets or between the frame and sprockets or it could jump off from the outer chain ring. It could also endanger your life as if the change falls off unexpectedly or gets jammed could throw you off your bike.



**DANGER:** Before every ride check your gears are working properly. Badly set gears or bent hangers can cause serious damage to your bike or lead to serious injuries.

Over time gear changing may get worse as gear inner cables can get snagged by dirt, water or other things. In this case we recommend you to grease the gear inner and outer cables again or if necessary replace them.

The moveable parts of the rear and front derailleur should always be lubricated with the recommended lubricant. (Especially after wet rides!). Only by doing this is it possible to guarantee the gears working without any problems.

Derailleur gears are characterised by a wide range of gears. For special use the chainrings or sprockets can be replaced with other ones. This then changes the gearing ratio. Your dealer can advise you in more detail.

If the chain jumps off the front chain rings then the front derailleur needs to be set. The area of tilt can be set just like the rear derailleur using the limit screws ("H" and "L").

Tighten the tension using the adjustable screw on the gear lever. For road bikes the tension can be adjusted using the adjusting screws.

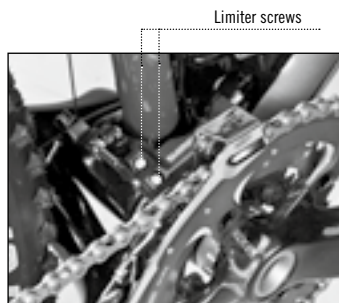

> Further notes about using, settings and warnings can be found in the gear manufacturer's user guide delivered with the bike.

## HUB GEARS

The advantage of hub gear is in their simplicity to use. Based on the capsule construction they are protected better from dirt.

For the hub gears used on our bikes it's possible to change gears when you're stationary and also when you're pedalling. It's also possible to change gear whilst you're braking (for example when you are approaching a crossroads). Thus you are already prepared and in the best gear for starting off again.

A technical speciality is the 14-speed hub gears by Rohloff. This high-end gearing system is extremely reliable and has a long-life whereby some maintenance work is necessary. Bikes with Rohloff gear systems are delivered with Rohloff all-year round oil. Detailed information can be found in Rohloff's user guide which comes with the bike.

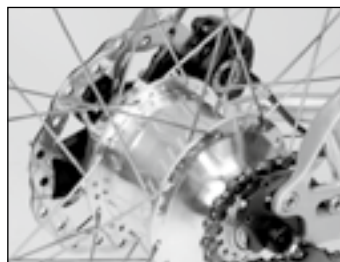

> Detailed user, settings and maintenance guide can be found in the gear manufacturer's user guide which comes with the bike.

Please pay attention to the warning notes in the chapter "coaster brake".



## COMBINED SYSTEMS

An interesting alternative especially for Active Lifestyle bikes are combined systems, where an integrated gear in the rear hub is combined with a derailleur system. "Dual Drive" system by SRAM is for example such a system. These systems have the advantage that only one chain ring is needed on the crank set but despite this a very wide range of gears is available.



Detailed user, settings and maintenance guide can be found in the gear manufacturer's user guide which comes with the bike.

## PEDALS

Please note that the right pedal (chainring side) has a right-hand thread and the left pedal has a left-hand thread. The right pedal is marked on the axle with (R) and the left one with (L). Grease the pedal thread and screw the pedals on with your hands first. With a suitable 15mm open-ended wrench or suitable hexagonal wrench tighten them very tightly. Regularly check whether the pedals are firmly screwed into the cranks.



**DANGER:** Don't put the pedal axle thread in at an angle, otherwise you will destroy the thread in the cranks. Make sure you adhere to the crank manufacturer's torque settings.

## SYSTEM PEDALS

(also called "click pedals") are safety pedals, where the plate on the sole of a shoe clicks into the mechanism in the pedal. Thus the foot cannot slide off the pedal and it's possible to pedal with a circular stroke. These pedals only work with special shoes and shoe plates manufactured for them. There are different pedal systems available which may not be combined with each other. Only use the original shoe plates suitable for the pedals.



**NOTE:** It's take some practice to get in and out of the click pedals. Familiarise yourself with the click pedals first. Practise on a smooth area with little traffic.

Make sure that both the shoe plates and the pedals are kept clean and free of as much dirt as possible. Dirt or small stones can get into the plates or the pedals, which can influence the functionality of the system. Check the wear & tear of the shoe plates regularly (especially with plastic plates). Worn plates may suddenly release themselves from the pedal or prevent getting out of the pedals without any problems. Always check that the fixing screws are firmly tightened.



**DANGER:** Only use your click pedals when they click in or out without any problems. If the click pedals don't work properly or with very worn plates the shoe may release itself from the pedal which could cause you to fall off your bike.

## CRANKS

The cranks may become loose over time during riding. Regularly check whether the crank arms are firmly secured on the axle. If you wiggle the crank arms there should be no play at all.

For detailed instructions about settings please consult the crank manufacturer's user guide which came with the bike.

**!** NOTE: Riding with loose crank arms leads to noises and can damage components. Regularly tighten the fixing bolts with the recommended torque settings.

## BOTTOM BRACKET, HEADSET AND HUB BEARINGS

Over time a little bit of play may occur in the bottom bracket, headset or hub bearings. This bearing play may have serious consequences for the riding characteristics of your bike. Riding with bearing play usually leads to very high wear & tear on the bearings. The frame or forks material can be damaged. We recommend you to have loose bearings seen to by a mechanic immediately.

### BOTTOM BRACKET

Our bikes only use "cartridge bottom brackets" which are fixed and cannot or need not be adjusted. This bracket cartridges are screwed into the thread of the frame or for frames with "PRESS-FIT" system they are pressed into the frame. Should the bottom bracket cartridges become loose, then the cranks arms have play in them or under strain knocking noises may occur. Consequently the frame can be damaged. This is why you should have your bike inspected by a mechanic as soon as you hear any cracking noises. For bottom brackets with metal threads please make sure that they are well-greased before you screw them into the frame. For frames with "Press-Fit" bottom brackets the bottom brackets are pressed directly into the frame via adapter cups. Only a specialist dealer with the necessary know-how and special tools can replace it.

### HEADSET

With "integrated or semi-integrated headsets" tighten the bearings in the following way:

- Open the clamping screws on the rear side of the stem one to two turns.
- Tighten the upper adjusting screw slightly but carefully.
- Align the stem so that the handlebars are not twisted when you are riding in a straight line.
- Tighten the stem clamping screws with the recommended torque settings.
- For forks with carbon shaft adhere to the special notes in the Chapter Setting up the bar height.

This job should be carried out by a professional!

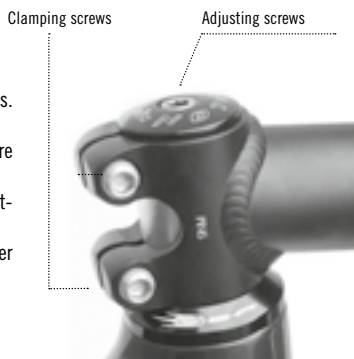

After setting the bearings check the stem is securely fastened. Take the front wheel in between your legs and try to turn the handlebars against it.

Setting up the headset bearings with road bikes which use "The Clamp" system from Acros is basically different. To do this please read the headset manufacturer's user guide.

**!** DANGER: Check the steering headset doesn't have any play before each ride. Loose headsets and stems could have a negative effect on the riding characteristics and may lead to you falling off.

## HUBS

The right settings for the hub bearings requires specialist knowledge and great finesse. This task should only be carried out by a professional mechanic.

## CHAIN

The chain should be lubricated regularly with a lubricant for bike chains, especially after riding in the rain. Dirty chains should be cleaned to prevent unnecessary wear & tear and to increase ease of movement (For cleaning see "Maintenance and Care"). After cleaning the chain don't forget to lubricate it.



- Apply chain oil to the clean as possible links.
- Then turn the chain several times and then leave the bike to stand for a few minutes so that the lubricant can be absorbed into the chain.
- Rub off any excess lubricant from the chain's surface with a rag, so that it doesn't sprax off during the ride.

**!** NOTE: Damaged chains don't only make changing gear more difficult but also lead to increased wear & tear on the sprockets and chain rings. Replacing them usually costs more than just replacing a chain.

NOTE: Please note that a chain belongs to the wear & tear parts and usually reaches its limit between 1,000 and 3,000 km. Your dealer has ways to measure the wear on a chain. Replace the worn chain with a new one. Replacing the chain needs special tools and knowledge. Let your local dealer do this for you.

Open chains may only be riveted together with special closing pins. Only by using this closing pin is it ensure that the rivet point can handle the same loads as the rest of the chain. Once you have joined the links with the closing pin don't open them again, as it's not possible to rivet it robustly again.

**!** DANGER: Chains may only be mounted with suitable tools. Badly riveted, inadequately closed or very worn chains may break and thus lead to a crash.

## HANDLEBARS / STEM

Lightweight handlebars are especially comfortable as they can absorb bumps very well. But it's still important to observe some safety guidelines.



**!** DANGER: Bent aluminium handlebars (via external influences such as crash, impact etc.) have been weakened and should not under any circumstances be bent back again. They need to be replaced due to risk of breaking.

**!** DANGER: Carbon handlebars may possibly after a crash show no visible damage or deformation, however the inner carbon structure may be damaged and the handlebars might be weakened. This is why after a heavy impact on the handlebars we strongly advise you to stop using those bars.

Furthermore it's important that the stem clamp and the bend of the handlebars are set up for each other. The edges of the handlebar stem clamp must be rounded off otherwise with aluminium handlebars contact corrosion will occur and the handlebars will be weakened or lightweight handlebars made from aluminium or carbon will be nicked and could be pre-damaged by this. Then a break is inevitable. For assembly use a torque wrench and adhere to the maximum allowed tightening torque.

**!** DANGER: Excessive tightening torque may damage the handlebars and stem!

**!** DANGER: Lightweight handlebars for mountain bikes and road bikes should be replaced in good time with heavy use. These handlebars may break unexpectedly and cause serious injuries.

Some handlebars are equipped with so-called bar ends. Check regularly whether these are securely fixed to the handlebars. The clamp should not damage the handlebars.

Bar ends on carbon handlebars are only permitted if the handlebars have been approved for bar ends. If necessary use bar end plugs to strengthen the clamping position.

**NOTE:** The secure fixing of the handlebars, the bar ends and the stem is an important point for your riding safety. It is recommended to check the screws on the handlebars, bar ends and stem regularly.

**!** DANGER: Loose stem clamps, loose handlebar clamps or loose bar end clamps can lead to a sudden slipping or twisting of that component. This leads to serious danger of falling off or injuring yourself.

**NOTE:** To ensure a secure fit, the contact point between the stem and fork steerer tube may not be greased. For forks with a carbon steerer the whole contact area between the steerer tube and stem, a special assembly paste needs to be applied to ensure the stem is securely fixed without overloading the fork steerer tube.



## LIGHTS

For your own safety check your lights before riding at dawn / dusk, in fog or at night. If there are problems check the bulbs, cables, cable connections and connectors. Clean the reflective areas of reflectors from time to time (dirty reflectors can hardly be seen in the dark).



**DANGER:** Only start riding at night if your lights are working properly. Replace any damaged components with components which bear the official mark of conformity (a wavy line with a five digit K-N°). Replace damaged reflectors before you start your ride. Only use officially approved reflectors.

## DYNAMO

Hub dynamos provide electricity in any weather conditions. Their efficiency and life span are with the premium models very good. No wear & tear on the tyres. Hub dynamos are electronically controlled. Combined with a light sensor in the headlight these dynamos switch the light on during your ride if your surroundings reach a certain darkness.



**DANGER:** Only start your ride at night if your lights are working properly.

## HEADLIGHT

The beam of the headlight may only shine on the road at about 10m distance. Otherwise the oncoming traffic may be blinded by the bike headlight. Check regularly whether the screws on the headlight are tight and whether the setting is correct. Replace defective bulbs immediately.



## REAR LIGHT

Your bike is equipped with a modern diode stationary rear light with light transmitting technology, which means you have the added safety that the rear light automatically continues to shine for a while after you stop after a certain time riding, making you more visible to other road users behind you. Diode rear lights don't have any bulbs. As the light diodes have a life span of approx. 100,000 hours, these are maintenance free.

## TYRES

Tyres can be bought in different sizes, with different profiles and different material characteristics. Above all they differ in riding characteristics such as braking, accelerating, cornering and their rolling resistance. Your bike is equipped with tyres which suit the type and use of your bike. When you change your tyres, please consult a specialist about your choice of tyres.



Make sure your tyres are inflated to the correct pressure. Notes about tyre pressure can be found on the sidewalls of the tyres. Not enough tyre pressure is the biggest hinderance on a bike. It wastes a lot of your energy and causes the tyres to wear prematurely.



On some tyres the direction of rotation should be adhered to. This is shown by markings on the sidewalls of the tyres.

Not enough tyre pressure or rims which are hot from braking may lead to the tyre with the inner tube wandering on the rim during your ride. After some time this means that the valve is at an angle and may tear. If you see a valve which has moved, then you should correct its position immediately. Let all the air out of your tyre and pull the tyre and tube back until the valve is straight again. Then pump up the tyre and check its circulation.

If the tyre is inflated to the recommended pressure then it's not so susceptible to punctures. So-called snake bites, which snag the tube when you ride over an edge often come from not enough air pressure.

**NOTE:** Never pump the tyre up above the allowed tyre pressure. The tyre only becomes harder but hardly decreases the rolling resistance any further. There is a danger that the tyre or the rim is then damaged by or bursts due to excessive pressure.

Tyres with worn down profile or porous sidewalls you should change immediately.

Your pump should fit the respective valve type. Basically there are three types of valve in common use (diagram from left to right):

- Dunlop valve
- Presta or scloverand valve
- Car valve



Before pumping up the presta valve (shown in the middle) the knurled nut on the valve needs to be unscrewed a little bit. Push the head of the pump onto the valve and pump the tyre up. Finally you need to tighten the screw of the valve again. To release air push the valve stem in a little bit, making sure the nut is loose, until some air comes out.

## TUBELESS TYRES

Tubeless tyres run as the name suggests without an inner tube. The special tyres, rims (more robust rim lip seals completely with the especially designed tyres) and valve keep the air in the tyres. Tubeless systems are much less prone to punctures. This means that the tyres can be ridden with lower air pressure which improves the ride comfort considerably.



In case of a puncture you can temporarily use a conventional inner tube.



**DANGER:** Always make sure you are riding with the correct tyre pressure. Not enough or too much pressure can lead to punctures and also to crashes with serious injuries.

## WHEELS

SIMPLON's own built wheels are "stabilised" via two special construction processes. Thanks to the stabilisation the setting process of the spokes and spoke nipples virtually disappears, which means that our wheels have nearly been "ridden in". Despite this, for safety reasons, we recommend you check the spoke tension before every ride during the first few months. Loose spokes should be tightened by a mechanic immediately.



**NOTE:** With each new bike the spokes will set after some kilometres riding. Some spokes may become loose.

Even after the riding in period the spokes may become loose over time. This is why you should check the spoke tension regularly. Push the two neighbouring spokes on the same side of the wheel together with your thumb and index finger. All spoke pairs should feel as though they have the same tension. Loose spokes are more susceptible to breaking and can distort the rims. Slightly distorted rims can be trued up again. Don't ride with loose or broken spokes otherwise the rim can be damaged.

For many types of brakes the sides of the rims are the braking surface. If the rims don't run true then it can hinder the brakes working properly. In an extreme case the brake pads may miss the rim surface and then run into the spokes which can lead to the wheels stopping immediately. This can lead to an extreme risk of crashing. Have your loose spokes tightened by a mechanic / bike shop at the earliest possible opportunity.



**NOTE:** Re-tensioning the spokes and aligning the rims needs a lot of skill and experience. If re-tensioning is done incorrectly the rim can be damaged. Only let your loose spokes be tightened by a mechanic.

Check your wheels are centred and running true occasionally: to do this lift the wheel off the ground and set it spinning by hand. Observe the distance between the brake pads and the rim. If this distance changes by more than 1mm during the rotation then the spokes should be re-tightened and the wheel centred again. Not enough tension on the spokes leads to an increased load on the spokes and the danger of a spoke breaking increases considerably. This is why the spoke tension should be checked regularly.

## REMOVING THE WHEEL

- Depending on the brake type open the brakes. For V-brakes the cable on the brake arm needs to be slipped out. To do this push the brake pads, or the brake arms together with one hand. This way you can slip the outer cable out easily.
- For hydraulic rim brakes you need to release the brake quick release lever to remove the wheel and disassemble the brake unit (for Kagu models, disassemble both sides).
- For side-pull brakes open the quick release lever on the brake for Shimano and SRAM models. For Campagnolo models move the lever on the shift-/brakelever on the handlebars.
- Don't turn bikes with disc brakes upside down to stop air getting into the system.
- Change to the smallest sprocket on the rear. This means the rear derailleur is then as far out as possible and doesn't hinder removing and inserting the wheel again.
- Open the quick release and if necessary turn the tensioning nut of the quick release a few times.
- Pull the rear derailleur slightly to the rear so that removing the rear wheel is easier.
- Lift the bike slightly, the wheel can now be removed easily, if it doesn't fall out itself.
- To insert the wheel again do the same in the reverse process. Make sure that the wheel is properly located in the drop-outs and is running centred. Now close and tighten the quick-release again and put the brakes back into their original position.



V-brake



Hydraulic rim brake



Side-pull brake

Mountain bikes with SRAM drive units are equipped with Type 2 Derailleurs. With these ones the cage can be tensioned and locked in. This makes it much easier to change the wheels.

When you change the wheel observe the possible rotational direction of the tyre (arrow on sidewall). After changing the wheels check that the brakes work properly again. Make sure you test the brakes again.



**DANGER:** The axle nuts or quick release mechanisms are a very important point on the bike. So never forget to tighten the axle bolts to the prescribed torque after changing the wheel or to check that the quick-release lever is tightened properly.



## QUICK RELEASE / THRU AXLES

Wheels with quick release axles are tightened with a quick-release lever. If the wheel isn't tightened enough, then open the quick-release lever again (to the "open" position), tighten the bolt on the other side slightly and then close the lever (move it to the "close" position again). Repeat this process until the wheel has been tightened properly.

Wheels are now being fastened more and more with more stable thru axles. The correct use and settings depends on the model. To do this follow the respective manufacturer's instructions (DT Swiss, Shimano...).

Let your dealer show you how to remove and insert the wheels again, so that you understand the correct technique for securing the wheel with a quick-release or thru-axle.



RIGHT



WRONG



THRU-AXLE



**DANGER:** Check before every ride that your wheels have been tightened properly. A quick-release lever that hasn't been closed properly may open again. This means the wheels could become loose during the ride which can lead to a serious crash.

## RIMS

With many braking systems the sidewalls of the rims are the braking surface. Make sure that the sidewalls of the rims are clean. Keep them free of dirt and grease. The brakes only work well on smooth, clean braking surfaces.

Special modern V-brakes exert high braking forces on the rims. However this also means more wear & tear on the rims. With badly worn rims there is a very high danger of breaking. In such a case the tyre can suddenly jump off the rim. There is a real danger of falling off. Some rim models are equipped with a rim wear indicator. A groove in the rim disappears with increased wear & tear. Or a hole or a line become visible on the braking surface before the rim is too worn-down. When these signs appear the rim should be replaced immediately.

- At the latest when the second set of brake pads are replaced the thickness of the walls of the rim should be checked.
- Clean the sides of the wheel rims regularly and look out for any metal shavings, dirt and crushed grains of sand.
- Pay attention to braking noises: a grain of sand ridden in over 10 km downhill with lots of braking and the rim can be "ground through".



**DANGER:** The rims should be checked regularly for damage or deformation and if necessary replaced. For rims with lots of miles the thickness of the walls of the rim flange should be checked regularly by a professional. Rims with wear indicator should be replaced as soon as this appears. Do not ride with well run down rims, as there is a high risk of injury.

## HUBS

Check the hub bearings regularly that there is no play. If there is play in the bearings then this needs to be solved and adjusted. Always keep the bearings well greased. The hubs are always subject to dirt and water. The hub bearings are well-protected but after a certain amount of riding need to be maintained. Clean and grease the hub bearings at least 1x per year.

Regular maintenance increases the life span of the hub bearings considerably.

**NOTE:** Maintenance and setting the hubs requires specialist knowledge and tools. This work should be carried out by a mechanic / specialist.

## FORKS

Information about the suspension forks can be found in the chapter "Suspension systems".

With fixed forks damage may occur if the fork blades are pressed together. This is why you need to make sure that a hub or transport holder is put in place. If the hub is removed and not secured for transport then you need to make sure that no lateral force is exerted on the forks.

**NOTE:** For forks with carbon shaft only a maximum of 30mm distance rings (spacers) may be inserted between the headset and stem (40mm for forks with aluminium shaft). An excess leads to increased load of the fork shaft and can lead to the forks breaking. So that the stem clamp has the biggest possible contact surface to the fork shaft the length needs to be determined exactly. The mounted stem may only protrude 2mm over the edge of the shaft steerer. A recommended alternative is to let the fork steerer protrude approx. 1mm over the stem and to insert a 2.5 - 5mm spacer above the stem.



Put assembly paste between the stem and the fork steerer. This reduces the necessary torque needed and the components will be unburdened. The assembly paste needs to be replaced as soon as the stem is moved on the fork steerer.



**DANGER:** For forks with carbon-fibre shaft it is imperative to observe the assembly instructions delivered with the forks and only to use the special clamp unit delivered with the forks. Disregard of this can lead to very serious injuries. Only a maximum of 5 mm spacers can be placed above the stem.



**DANGER:** cable binders for computer sensors may only be tightened by hand and a rubber cushion must be placed between the sensor and fork blade. Ignoring this may lead to the forks breaking and cause serious injuries.

## FRAME

The core of your SIMPLON bike is the frame. The frame is constructed for the respective use and the loads associated with it.

Our bikes are robust, however with the wrong excessive strain can be destroyed.

A road bike frame is not designed for riding off-road. Do not do any jumps, even with a mountain bike. The bike and also you can suffer damage. If you see any display jumps you need to realise that these acrobats have special bikes and have learnt the techniques from constant training. But even these great cyclists have already damaged many frames and components during their training.

Damage can occur to the frame when the rear end is pressed together. For this reason always ensure that a hub or security for transport is inserted. If the hub is removed and no transport security is inserted, then make sure that no lateral force is exerted on the frame. Reality shows that even when transporting bikes in hardcase cases you shouldn't neglect this precaution.



Transport security

If you or your mechanic are using a repair stand where the bike is held with a gripper then make sure that this is only used on the seatpost. Lightweight frames, especially carbon frames are constructed for high loads during cycling. However the frames are very delicate to loads on the sidewalls of the frame tubes. Do not use any children's seats or car bike racks which are assembled using a frame clamp. Rear end side stands are not permitted on carbon frames and damage the frame.

## ACTUAL NOISE

Carbon frames transmit noises more intensively than aluminium ones due to their large resonance chamber. This is why sometimes noises which are caused by components sometimes seem to come from problems with the frame.

## CARBON-FIBRE SURFACE

Especially our frames and forks which, are made of carbon-fibre, were developed for best ride quality. Our manufacturing process and many steps made by hand are the source of small imperfections in the surface structure. Such imperfections might be for example small waves in the carbon weave or small air pockets in the top layer of the resin. Such "blemishes" are only optical and are no cause for a warranty claim. You can be sure that every SIMPLON frame has passed our extensive quality control and possible cosmetic variations have no negative influence on the function and performance of the frame.

## INVISIBLE DAMAGE

All frames and forks must be checked carefully for damage (fractures, dents ...). With carbon frames and carbon forks knocks can cause non-visible damage (delamination between the individual fibre layers). After crashes or accidents it is especially advisable to monitor the components more frequently and for safety reasons, if there are any changes at all, to ask for specialist advice.



**DANGER:** With lightweight aluminium and carbon frames avoid using any children's seats, bike rack carriers, rear-mounted stands etc. which are attached to the frame. Also avoid using a bike repair stand where the bike is held with grip jaws. The frames are not designed for such stress on the sidewalls and can be destroyed by this. With carbon frames do not sit on the top tube! Weight optimised frames have thin walls at this point and could get fissures from this.

## SUSPENSION SYSTEMS

Modern bikes are often equipped with suspension systems (suspension forks, suspension seatposts, suspension elements integrated into the frame) to improve ride comfort and braking control. To be able to profit from the desired advantages the respective suspension systems need to be set up properly and also adjusted for the rider. Notes about how to set them up can be found in the respective manufacturer's user guide.

The settings for the suspension elements also influence the riding behaviour of the bike. After you have changed the settings get used to the changed ride and braking behaviour by taking a test ride in a safe area.

## SUSPENSION FORKS

When the front wheel gets a knock the lower part of the forks will be pushed upwards, the forks slide together. A spring inside the fork is compressed and ensures that the forks go back to their original position after the compression. So that the spring doesn't unwind suddenly and the rebound is more controlled an oil damper is integrated into the forks.

Suspension forks differ in the type of spring element used and in the damper type. As spring material, air, steel springs or special plastic types (elastomers) or a combination of these are used.

For suspension forks:

- Check the air pressure for air forks.
- Are the seals o.k.? Are the inner fork tubes badly smeared with oil? Is oil coming out of the seal? In this case the seals should be replaced.
- Once a month put some oil on the seal between the inner and outer fork tube.
- Have all threaded joints on the forks checked over regularly.
- Make sure the sliding surfaces of the fork inner tube are clean.

Depending on the type of fork the spring and damper settings can be adjusted via a rotating knob or by changing the air pressure. If the possibilities for adjustment are not sufficient then other springs or dampers need to be mounted. However this replacement needs to be done by a bike dealer.



**!** DANGER: Changing the suspension forks setting may limit the ride and braking characteristics of the bike.

Some forks are equipped with a "lock-out system". These forks can be stiffened by changing the setting of the compression damper.

To avoid damaging the damping system these forks have an excess pressure valve which is activated by knocks so that the forks also absorb in lock-out mode. Despite the excess pressure valve you should only activate the "lock-out" when you are riding on tarmac or uphill to help preserve the fork and frame. When you are riding downhill you should always turn off the "lock-out" for the forks.

Adjusting the fork to your personal requirements:

- Start with setting up the fork with rolled back spring pre-load and to the lowest damper stage.
- Put a cable binder over the fork inner tube so that it can still move easily.
- The fork should compress about 15 - 35 % of their maximum travel when you sit on the bike. If this isn't the case then you need to change the suspension pre-load.
- Ride over mixed terrain and then see how much of the travel you have used. If the cable binder has only moved a few millimetres then the fork has been set up too hard. Check whether the spring pre-load has been fully rolled back and if necessary get the springs replaced.
- If the cable binder has been moved the whole length or the fork bottoms out with an audible noise, then the spring is too soft. Tension the springs. If the behaviour doesn't improve then let the springs be replaced by a specialist. (If you can't put any cable binders on the fork inner tube then you need a co-rider who observes the forks behaviour during your ride).
- If you have found the right settings for the springs, now begin to start the damping. Start with small steps and observe the speed at which the fork de-compresses. With not enough damping the decompression happens quickly. You get the feeling when riding as if the bike wants to throw you off it.
- The harder you set the damping the slower the spring de-compresses. The swing up effect is smaller. Too much damping means that the fork compresses more and more when there are lots of fast bumps after each other as it cannot de-compress fast enough.
- For systems with a platform style damper you should adjust the suspension fork according to the instructions from the respective manufacturer.

**>** For how to use it, set it up and maintenance notes please read the manufacturer's user guide delivered with the bike.

## SUSPENSION SEATPOSTS

Suspension seatposts increase the comfort on unlevel ground. However they do not offer the benefits of a full suspension frame. They are not suitable for downhill rides. The spring tension can be changed to achieve the desired suspension characteristics.

- To change the spring tension take the seatpost out of the frame.
- The adjusting screw is at the bottom of the seatpost.
- To increase the tension turn the adjustment screw clockwise.
- To slacken the spring turn it anti-clockwise.



Models with MCU elastomers are roughly set to the weight of the rider by shortening the elastomer. Models with steel springs are roughly set to the rider's weight by replacing the steel springs. To do this please comply with the seatpost manufacturer's user guide.

With some seatposts it's possible to adjust the lateral play via one or more play adjustment screw(s). Small amount of play is necessary for it to work properly. Too much play prevents the suspension from working well and leads to premature wear on the bearings. Check the lateral play regularly and set it according to the seatpost manufacturer's instructions. Have the suspension seatpost serviced after a certain operating period (according to the seatpost manufacturer's user guide).



## REAR SUSPENSION

Full suspension bikes have in addition to suspension forks also a moveable rear end, which is sprung and damped via a shock absorber. When you sit on the bike the suspension for the rear wheel arm sinks in a bit so that a negative suspension travel occurs, so called sag. This spring relaxes when you ride over a bump the rear wheel arm compensates for the bump. To be able to benefit from the advantages of a full-suspension bike, the bike must be tuned to the rider's weight, type of rider and use.

A cross-country mountain biker sets the suspension a bit harder than someone out on a tour. However the sag should not be set too soft so that it doesn't bottom out. You could feel this with hard knocks where the suspension is pushed together quickly and completely.



**DANGER:** Do not ride with a bottoming out damper. The damper itself or the frame could be irreparably damaged.

- When you sit on the bike it should only compress approx. 20-35% of the maximum travel.
- For air suspension shocks the tuning is done via the air pressure. Make sure that you only use a pump suitable for this and comply with the shock manufacturer's maximum allowed air pressure.
- The damping is set externally via a small wheel (or a lever). Turn this in small steps and test how the damper reacts.
- The correct damping has been achieved when the rear frame bounces once after you have ridden off a high kerbstone.

Some shocks are equipped with a "lock-out" function. The suspension becomes very hard with this function. If you turn the lock-out lever the rear shock is nearly rigid. This function is useful on level smooth ground (such as tarmac) or uphill sections where you are out of the saddle on smooth ground. But on downhill sections or in rough terrain a full-suspension bike should never be blocked.

**NOTE:** For riding downhill or uneven ground the shock absorber of a full-suspension bike should never be completely blocked. Full suspension frames are not designed for greater strain with blocked suspension systems and could be damaged by this.

> Damper technology is changing very quickly. Please adhere to the shock absorber manufacturer's user guide which comes with the bike.

The maintenance of the frame is often focused on cleaning the bearing area and the shaft. Do not use any harsh detergents or high-pressure cleaners. Check whether the bearings have any play or not:

- To do this lift the bike by the saddle and try to move the rear wheel sideways back and forth.
- To check for any play in the shaft, put the rear wheel on the ground and lift it up again. Pay attention if there are any rattling noises.
- Any play in the bearings should be re-adjusted by a mechanic and eliminated.

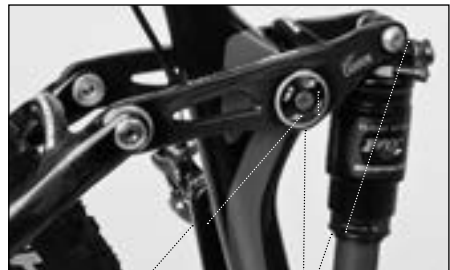

Swing arm bearing cover

Fixing screws

The screws for the rear shock and the rear arm bearings should be checked regularly that they are tight (observe the maximum torque).

**NOTE:** After a longer operating period it is recommended to have the forks and rear shock serviced by a specialist or is even compulsory to fulfil the warranty conditions. This ensures that the shock will work and last for a long time. Details can be found in the user guide for the fork or rear shock.

## 5. WORTHWHILE NOTES ABOUT YOUR BIKE

### TRANSPORTING CHILDREN

It is only allowed to transport children in special seats or child trailers. The mounting brackets for child seats are often attached directly to the frame. Please adhere to the instructions from the respective manufacturer when mounting them. Under no circumstances should children's seats which are attached with mounting brackets be attached to carbon or very light aluminium frames.

It should be noted that the riding behaviour will be negatively influenced by the weight of the seat and the child. Especially practise getting on and off the bike! It's important that the child is strapped into the seat and the feet are resting properly in the special foot holders. Before you set off always put a helmet on the child's head.

### BIKE TRANSPORT

There are different bike rack systems for transporting bikes with your car:

#### ON THE ROOF

By mounting the bikes on a rail standing and a clamp on the down tube which holds them in place. If you are not careful or if the clamp device is too hard or you fasten it too tightly the frame tube can be damaged. With another system the front wheel is taken out and the bike is held with a quick release holder which holds the fork dropouts, and the rear wheel is held in place by a rail.

Do not use any rack systems where the bike is upside down and the bars and saddle are fastened to the bike rack. This leads to too much pressure being put on the bars and saddle during driving.

#### ON THE REAR

Different rear bike rack variants are available. These have the advantage that the bike doesn't have to be lifted up as high. Additionally they cause considerably less wind resistance.



**DANGER:** Lightweight aluminium and carbon frames should not be fixed with the traditional frame clamps to the car bike rack. Such clamps will damage the frames. For lightweight aluminium frames, aluminium frames with non-circular tubes and carbon frames only bike racks without frame clamps and roof racks with hub fixing may be used.

For transport with rear wheel removed (i.e. in a car or in a bike case) the following needs to be adhered to. Lateral pressure on non-supported rear frame stays can lead to irreparable damage. Support can be provided with the rear hub. With removed rear wheel and possible pressure on the frame (even hard-shell cases don't offer enough protection) this is why some type of transport securing device (i.e. loose rear hub) should be inserted.



**DANGER:** For transporting your bike with rear wheel removed you must place a security device for transport between the rear drop outs. If not, it may lead to irreparable frame damage.



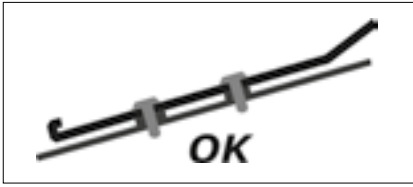

Diagram A



Diagram B

The threaded inserts for mounting bottle cages are for fixing common bottle cages with M5 threaded screws. The maximum torque for the bottle cage screws is 5 Nm.

The bottle cages need to have a design such that these are flush with the threaded inserts (Diagram A). Bottle cages which are supported by the tube (Diagram B) are not allowed, as these could cause the threaded inserts to be torn out.

If a pump holder is screwed to the bottle cage, make sure that no gap between screw, holder and thread base exists, otherwise the thread base can be torn out.

## 6. CARE AND MAINTENANCE

### CLEANING

Different materials and mechanisms also need their care and maintenance. Components with only a limited product life last longer thanks to good care and maintenance, but still show signs of fatigue. Fractures and discolouration are signals of such signs of fatigue.

Cleaning your bike should also be a chance to check it over as well. Check at the same time you are cleaning it, the bike for fractures or scratches, damaged shift and brake cables, loose spokes, loose screws and other components whether they are damaged or defective which need to be replaced.

To clean your bike take a sponge or cloth with clear water. Be careful when cleaning with a high-pressure hose. The water jet which is under a lot of pressure can push past the seals into the bearings. This then can flush out the grease which will destroy the bearing running surface. Especially when using the bike in winter cleaning, should be carried out more regularly so that de-icing salt doesn't cause any damage.



Take care when cleaning the chain: Do not use petrol, spirits, petroleum or similar. Also avoid cleaning the chain with a high-pressure hose. The "cleaning agents" mentioned here wash the chain out completely and make the material "dry". Chains which are cleaned in this way can only be saved by giving them a hot chain oil bath. Clean the chain of existing dirt with an oily rag.

The chain and the moveable components of the shifting components need to be lubricated regularly after the cleaning. Conserve paint, spokes, metallic surfaces etc. after the cleaning with a spray or hard wax. Protect the metallic components with a thin film of oil. Ideal for this is penetrating oil which penetrates into the smallest gaps and protects the chain from corrosion.

Also for frames and components made of carbon we recommend cleaning with a bike cleaner or warm soapy water and then treating the surface with a protective coat for example a protective wax spray (i.e. Dynamic protective wax). The pores in the paint surface but also possible raw carbon fibre surfaces will be protected from damaging environmental influences and additionally cleaning will be easier. Carbon fibre is susceptible to abrasion, this is why contact points with components (i.e. brake and gear cable housing) should be protected from abrasion with a robust polyurethane protective film.



**DANGER:** Don't get any cleaning agent or chain oil onto the brake pads and the brake surfaces of the rims! This could limit the braking efficiency. Your safety is in danger. For disc brakes any grease or oil on the rotor disc has a considerable effect on the braking effect. The brake pads become unusable.

## FLAT TYRE

If your tyre is losing air, either the valve is defective or the inner tube has a hole in it. Check the valve first. If the air loss isn't from the valve then you need to fix the puncture. To do this remove the respective wheel from the bike (See Chapter "Wheel removal").

Once the wheel has been removed you can change the inner tube:

- Let the remaining air out and remove the valve nut.
- Loosen a sidewall of the tyre from the rim using plastic tyre levers.
- Remove the defective inner tube.
- Always check the tyre for foreign bodies after punctures to prevent further damage.
- Check the rim tape is seated properly. The rim tape needs to cover all spoke nipples.
- Then inflate the new inner tube slightly (so that it takes on its round shape again) and insert it again.
- With your thumbs push the sidewall of the tyre back onto the rim. Make sure that you don't pinch the inner tube between the tyre and the rim.
- Inflate the tyre to the stipulated tyre pressure and then insert the wheel correctly again.



Removal



Assembly

So a defective tyre doesn't cause a long delay out on a ride, always take a puncture repair set with you, consisting of:

- Spare inner tube
- Plastic tyre levers
- Pump / air cartridge

**!** DANGER: As spare parts only use tyres and inner tubes which have the same specifications.

For tubeless tyres (UST-System) you can use a normal inner tube if you have a puncture, so that you can continue your tour. However remove the inner tube as quickly as possible and restore the original tubeless system again.



NOTE: We recommend special sealant milk for use with tubeless tyres. In case of a puncture (i.e. by thorns) this seals the hole immediately and prevents further loss of tyre air pressure.

No tyre levers should be used with UST tyres. These could damage the sealing lip of the tyre.

**!** NOTE: Also tubeless tyres which are equipped with a Kevlar core should not be folded. As this could damage the sealing lip of the tyre.

## CRASH

After a crash first check whether you have been injured and if necessary seek medical attention. A crash puts more strain on the bike than normal. After a crash check the state of your bike or the components. Bent, discoloured or deeply scratched components should not be used unconditionally. Let these components be checked by your dealer and if necessary replaced.

**!** DANGER: A crash puts more strain on the material than normal. Due to material fatigue components can break without warning which can have catastrophic consequences.

If you are in any doubt about the state of your bike or individual components, then have your bike checked over by your dealer or a bike expert.

**!** NOTE: Carbon frames need to be checked over for fractures or delamination after external influences such as a crash or impact. Due to the material characteristics of carbon components no dents occur. A carbon frame can be damaged without it being immediately noticeable in its ride behaviour. Carrying on using the carbon frame could weaken it even further until it breaks.

## TRAINING ON ROLLERS

All SIMPLON frames and forks may be used on rollers where there is no rigid clamping.

If the bike is used on turbo trainers, where the rear wheel is clamped in, it is not permitted to "ride out of the saddle" as this leads to premature fatigue on the frame.

If you "ride out of the saddle" on such rollers or turbo trainers the frame warranty will automatically become void. Riding in the saddle with moderate force on turbo trainers where the rear wheel is clamped in is allowed with no restrictions on the warranty.

## GENERAL TIPS FOR CARE

Despite premium quality paintwork or anodisation the surface areas of our frames still require regular care. Especially after contact with sweat, electrolyte drinks or road salt the surfaces and nodes should be cleaned thoroughly and then sealed with a typical protective wax spray for bikes such as Dynamic protective wax. Body perspiration, sea air, road salt as well as aggressive cleaning agents can permeate the varnish and infiltrate the layers of paint. Both with aluminium as well as carbon frames. Avoid direct unprotected contact with these materials and seal the surface of your bike regularly. Damage which occurs due to oxidation are excluded from warranty claims.

Some chemicals in adhesive strips or tapes, stickers and protective film can attack and detach bike paint. Especially if stickers remain on the paint for a longer time, when they are removed, they may pull some paintwork of the frame away with it. As we have no influence on the behaviour of stickers which are subsequently added, such damage is also excluded from the warranty.

**NOTE:** Even premium well-sealed bearings are not resistant to the strain of high-pressure hoses and especially penetrant water jets. Damage which occurs from water entering the parts are no reason for complaints.

If you rarely or hardly use your bike during the winter months, this is the time to bring it to your dealer for its regular inspection and service. The waiting times are the shortest and the mechanic can take care of your bike without being rushed.

After approximately 10 - 15 hours riding or 100 - 200 km you should take your bike in for its first inspection. During the riding in time the cables may stretch, spokes may bed in, the gears might shift etc. This is why you should agree on a mutual time for the first check-up with your dealer. However if anything seems to malfunction with your bike, bring it to a specialist dealer. Keep to the agreed inspection intervals in the maintenance table.

Often noises which seem to come from the bottom bracket don't actually come from there but are caused by other parts.

A common cause for regular creaking noises are the spokes of the wheels (spokes rubbing on each other). The best way to avoid this is to oil all intersection points lightly.

Another source for popping or cracking noises is the rear cassette. To eliminate these noises remove the cassette and rub copper paste onto the surface of the freehub body. After this mount the rear cassette and tighten it with the locking ring with the maximum permitted torque according to the manufacturer's specifications.

If you are in any doubt as to whether you can carry this out yourself or you don't have the necessary knowledge or tools to do the job yourself, then contact a mechanic.

## SCRATCHES TO THE FRAME / FORKS

Due to carelessness during transport, crashes or flying stones can cause damage to the paintwork. Even small scratches should be treated immediately with clear varnish, as otherwise the paint layers can be infiltrated. The frame will then corrode under the paintwork and after a while extensive paint damage will occur.

- Clean the area, remove paintwork chippings and wet abrasive paper (800 grade) roughen it up carefully.
- Degrease well with alcohol
- Apply clear varnish and let it dry until the paint has completely hardened. To compensate for uneven surfaces paint it again and let it dry.
- For optical perfection rub down the painted area with wet abrasive paper (2000 grade) and then polish it up with a polish paste up to a high glossy finish.
- Seal it with protective wax.

**NOTE:** Do not put protective wax onto the brake surfaces otherwise the braking efficiency will be severely reduced.

If the frame or forks are extensively re-painted then the warranty will expire as we have no influence on the prep-work or paintwork and it may come to hidden preliminary damage of the frame or forks (i.e. from excessive temperature during painting).

## CARBON ASSEMBLY PASTE

The SIMPLON assembly paste (or special carbon assembly paste from other manufacturers) increases the friction coefficient and separates carbon components on the bike.

Before the stem is finally mounted all clamping surfaces should be smeared lightly with the assembly paste. By using the paste during assembly the anti-twist security is achieved at a clearly lower torque level for the screws. This means that the screws and the components are subject to much less strain.

With the seatpost an anti-slip fixing can be achieved with less torque or closing force of the quick-release. Also it will minimise the danger of the carbon seatpost "becoming stuck" in the frame. Please note that the solid parts contained in the assembly paste may cause scratches on the surface when you move the seatpost.

Assembly paste should also be used on the clamps from front derailleurs on the seat tube, so that the clamp can also grip with a low torque setting.



## SERVICE INTERVALS

| Component                               | Task   | Before every ride | Monthly | Annually | Other frequency                       |
|---|--|-------------------|---------|----------|---------------------------------------|
| Nuts and bolts                          | Check, tighten   |                   | *       |          |                                       |
| Paintwork, metal parts                  | Preserve   |                   |         |          | Every 3 months                        |
| Seatpost                                | Remove and lubricate<br>Check screws   |                   | *       | *        |                                       |
| (suspension) Seatpost                   | Check for play   |                   | *       |          |                                       |
| Dropper seatpost                        | Clean coated tube with damp cloth. Check functionality   | *                 |         |          |                                       |
| Brakes                                  | Check functionality, thickness of pads and position against the rim, brake test<br>Visually check the brake cables | *                 | *       |          | See manufacturer's specifications     |
| Gears                                   | Clean and lubricate front & rear   |                   | *       |          |                                       |
| Gear / brake cables                     | Disassemble and grease   |                   |         | *        |                                       |
| Pedals                                  | Check for play<br>Clean and lubricate click mechanism  |                   | *       | *        |                                       |
| Crank arms                              | Check, tighten   |                   |         | *        |                                       |
| Bottom bracket                          | Check for play   |                   | *       |          |                                       |
| Headset bearings                        | Check for play<br>Have it greased  |                   | *       | *        |                                       |
| Hub bearings                            | Check for play<br>Grease   |                   | *       | *        |                                       |
| Chain                                   | Check and lubricate<br>Check and replace   | *                 |         |          | ca. 2000 km                           |
| Handlebars                              | Check or replace   |                   |         |          | at least every 2 years or after crash |
| (Traditional) stem                      | Disassemble and grease   |                   |         | *        |                                       |
| Lights                                  | Check  | *                 |         |          |                                       |
| Tyres                                   | Check tyre pressure, valve position<br>Check tyre tread and sidewalls  | *                 | *       |          |                                       |
| Wheels                                  | Check tightened<br>Check run smoothly and true, tension of spokes<br>Check thickness of rim walls                  | *                 | *       | *        | At latest after 2nd set of brake pads |
| Suspension Forks (springs / elastomers) | Change oil or grease elastomers<br>Check bolts   |                   | *       | *        | See manufacturer's specifications     |
| Suspension forks (air)                  | Check air pressure<br>Send in for service  |                   | *       | *        | See manufacturer's specifications     |
| Rear shock air type                     | Check over, air pressure<br>Clean bearing points<br>Send in for service  |                   | *       | *        | See manufacturer's specifications     |

## TIGHTENING TORQUE

**!** DANGER: The maximum torque settings must be complied with. If these are exceeded, then components may be damaged or destroyed, where over time or during riding it may lead to complete failure which could have serious crash consequences.

Approach the torque setting with lower settings where the component is securely fixed. Increase the torque settings gradually with a torque wrench and always check whether the component has been tightened enough or not. Often the component is secure before the maximum torque setting has been reached. Check the screws / bolts after approximately 200 - 400 km again according to the service table.

The maximum torque is a value which may not be exceeded. Often a lower torque is sufficient for the component to be secure.

Especially when using assembly paste the torque can often be much lower than this value as the solid particles in the assembly paste significantly increase the friction.

Tip: The lower the torque of the screws the less the component is put under strain. This is especially important for carbon frames and carbon components.

NOTE: The recommended torque values can be found in the table provided with these instructions.

For torque values which haven't been quoted in the table, the component manufacturer's recommendations apply. Especially if the recommendations from the components manufacturer are lower than those torque level quoted by us.

NOTE: With connections which consist of two or more screws tighten (i.e. handlebar stem) the screws alternately in small steps until all screws have been tightened equally. One exception is the Simplon ZERO handlebar stem. Here both upper handlebar clamp screws need to be tightened first and then both lower screws (up to the maximum permissible torque, however generally less torque is also possible to tighten the handlebars securely).

**!** NOTE: The minimum screw in depth must be adhered to. For hard aluminium alloys this is at least 1.4 times the diameter of the screw. Generally it is not the screws but the component which is the weak point.

## 7. SAFETY INSTRUCTIONS

---

Here is a summary of a few points, which need to be adhered to, to ensure your safety:

- Avoid dangerous situations.
- Wear the right clothing and a bike helmet.
- Respect the environment.
- Always lock your bike up, when it's left unattended.
- To ride on the road your bike needs to comply with the respective country's road traffic regulations.
- Only use the bike for the use it was designed for.
- Respect the maximum load and the different handling when it is loaded.
- The seatpost must be inserted up to the minimum insertion depth in the frame. Always keep the quick release lever for the seatpost clamp firmly and properly closed.
- After the handlebars have been adjusted, always check the handlebar-stem unit has been securely tightened.
- Apply both brakes smoothly so that the wheels do not lock up.
- Clean and check the state of the rims and replace worn rims in good time.
- Make sure the brake pads are sitting correctly and tightly so that they don't slide off and go into the spokes or damage the tyres. Check the thickness of the brake pads.
- For hydraulic brakes the hydraulic lines and connectors need to be absolutely leak-proof.
- Keep the headset bearings correctly set up. Loose headset bearings and stems can have a negative effect on riding characteristics.
- During long descents always release the brake occasionally so that the brake system does not over heat.
- Let your hot brake discs or coaster brakes cool off.
- For disc brakes only use brake pads which have been run in. Do not touch hot brake discs and brake calipers.
- Keep your derailleurs adjusted so that the chain doesn't jump off the chainring when you change gear.
- Only start your journey in the dark if your lights are working properly and the dynamo has been tightened properly.
- Make sure the tyres are pumped up to the correct pressure. Replace worn tyres with new ones.
- Chains need to be changed in good time. To do this it's important to use the appropriate tools.
- Replace damaged bars immediately. Replace lightweight bars after about one year so that these do not suddenly break.
- Close the wheel quick release lever tightly and properly.
- Rims should be checked regularly for damage or other possible deformation and replace them if necessary.
- Lightweight frames, especially carbon frames are very sensitive to loads on the sidewalls of the frame tubes.
- Changing the suspension settings affects the riding and braking characteristics of the bike.
- Don't ride with a shock which is bottoming out. The shock itself, or the frame with full-suspension bikes could be damaged irreparably.
- Full-Suspension frames are not designed for greater stress such as riding downhill or riding over rough terrain with locked-out suspension system. They could be damaged by this.
- Check your material after a crash. A crash puts an abnormal strain on the material.



## 8. TERMS OF WARRANTY

### WARRANTY PERIOD

The compulsory warranty within the EU is 24 months from the first date of purchase.

In some markets SIMPLON offers an additional non-compulsory extension of the warranty period by 24 months for breakage of SIMPLON frame or forks, if this was caused by material or manufacturing error. The additional extended warranty does not include labour or transport costs for the re-build. It is limited to the replacement or repair of the defect component.

After free online registration on [www.simplon.com](http://www.simplon.com) by the initial buyer within 20 days from the date of purchase this breakage warranty will be extended by a further 24 months which means extended up to 6 years in total (extended warranty is not available in all markets).

The compulsory legal warranty is not restricted by the optionally extended warranty by SIMPLON. The optional extended warranty is only valid if the frame or forks break. For paintwork the legal warranty conditions apply.

The optional extended breakage warranty is only valid for the initial buyer and is non-transferable. It does not include any labour or transport costs for the re-build and is limited to replacement or repair of the defective component. The adherence to the warranty conditions is a pre-requisite for a claim under warranty.

### WARRANTY CONDITIONS

- The warranty is only valid for the initial buyer of the affected bike and is non-transferable.
- If a claim is made under warranty, then the warranty period will not be extended nor will it start again.
- Present the completed bike pass stamped with the dealer's stamp, as well as the purchase receipt. Both are absolutely necessary. Otherwise dealing positively and quickly with the warranty is not possible.
- SIMPLON reserves the right to reject rectifying defects, if the necessary documents are not presented with the parts subject to complaint or if the bike pass is incomplete, illegible or the entries can be proven to have been faked.
- The guarantee / warranty does not include any of the following points:
  - Accidents or other events which were not in the power of SIMPLON
  - Repairs by third parties who are not authorised SIMPLON specialist dealers.
  - Bikes where the frame number has been changed, removed or made illegible.
  - SIMPLON frame or rigid forks which have re-painted
- A claim under warranty should always be made at an authorised SIMPLON specialist dealer (in the best case at the dealer where you bought the bike).
- In the case of a claim under warranty, SIMPLON has the possibility to repair or replace the defect parts at their own discretion. Should a component of the same type, size or colour no longer be available SIMPLON can make a part available which is seen as the successor part to fulfil the claim under warranty. The warranty is limited to the repair or replacement of defective parts. In addition no further claims can be asserted.
- The extended warranty period, which exceeds the statutory warranty, is only valid for the defective component. Any necessary labour or incurred packaging or shipping costs have to be borne by the buyer. - To be able to profit from the extended warranty, after 100-200 kilometres all moving parts need to be checked for their setting, as well as all nuts, screws, cranks, pedals, spoke nipples have to be re-tightened and the first service needs to be confirmed in the service check list.
- Parts excluded from the warranty, are parts which have been subject to natural wear & tear, i.e. bulbs, chains, tyres, rims, brake pads, grips, hubs, headset and gear bearings, rear end bearings and damper bushes as well as any damage which has come from improper handling, poor maintenance and care or normal wear & tear.
- If the frame or forks are re-painted the warranty becomes void, as we have no influence on the preliminary work and the paintwork, as the frame or forks might be subject to invisible pre-impairment.

- Furthermore no claim can be made under warranty if changes have been made to the original construction or the bike wasn't used under normal circumstances (i.e. freestyle, stunt shows etc. or any other excessive strain. Also excluded are any claims for late side-effects which are a result of previous crashes or accidents.
- For damages which are caused by non-compatible or unsuitable add-on components no claim under warranty is possible.
- The technology of our carbon frames is designed to be especially extremely lightweight. This is why the visible carbon fibre has an important supportive function at the points where it is only clearly lacquered. Carbon's reflexive behaviour makes even minor shifts in the carbon weave visible. Such irregularities occur for technological reasons and cannot be completely prevented, this is why they are not a manufacturing fault.
- Due to the special behaviour in real life it's possible that hairline cracks or fractures may occur in the filling or paintlayer during its lifetime, as due to aging the filling or paint layers become more SPRÖDER. Such cracks are only small cosmetic minor defects and are not a reason for claiming under warranty.

## CRASH REPLACEMENT

As the first owner not to leave you in the lurch in difficult situations, in some markets we offer a Crash Replacement on our carbon frames and carbon forks from the 2010 model year for 2 years after the date of purchase. This gives you the possibility to buy a new component at special conditions within the first 2 years from date of purchase. To be able to claim under the crash replacement programme it is imperative that you register your bike within 20 days after the date of purchase (see also "warranty period").

Detailed terms and conditions about the processing can be found on our website [www.simplon.com](http://www.simplon.com) under the item "Service / Extended Warranty".

# PROOF OF SERVICE

---

From the following checklist you can see when the next service is due and agree a date with your dealer in due course. Depending on the circumstances proof of service is also important in the case of a warranty claim. This is why it's always important the dealer confirms that the service was carried out on your bike.

1<sup>st</sup> SERVICE: after approx. 100 - 200 km or 3 months after date of purchase

Date Dealer stamp and signature

2<sup>nd</sup> SERVICE: after approx. 1,000 km or 6 months after date of purchase

Date Dealer stamp and signature

3<sup>rd</sup> SERVICE: after approx. 2,000 km or 1 year after date of purchase

Date Dealer stamp and signature

4<sup>th</sup> SERVICE: After approx. 4,000 km or 2 years after date of purchase

Date Dealer stamp and signature

5<sup>th</sup> SERVICE: after approx. 6,000 km or 3 years after date of purchase

Date Dealer stamp and signature

# BIKE PASS

---

Please complete your bike pass in full and have it stamped by your SIMPLON dealer. Should your bike be stolen, then you have all important information to-hand.

Surname, First Name

Address

Bike model

Frame size

Frame colour

Frame number  
(can be found underneath  
the bottom bracket)

Rear shock number  
(if it exists)

Fork model

Fork number  
(if it exists)

Special equipment  
(if appropriate)

Dealer stamp, signature  
and date of purchase

Frame mechanic

Bike mechanic